

TVNext™ (NN01-054) – Mobile TV (VHF)

Fractus Antennas specializes in enabling effective mobile communications. Using Fractus technology, we design and manufacture optimized antennas to make your wireless devices more competitive. Our mission is to help our clients develop innovative products and accelerate their time to market through our expertise in antenna design, testing and manufacturing.



TVNext™

NN01-054

Fractus Antennas products are protected by [Fractus patents](#).

All information contained within this document is property of Fractus Antennas and is subject to change without prior notice. Information is provided “as is” and without warranties. It is prohibited to copy or reproduce this information without prior approval.

Fractus Antennas is an ISO 9001:2015 certified company. All our antennas are lead-free and RoHS compliant.

ISO 9001: 2015 Certified



INDEX OF CHAPTERS

1. ANTENNA DESCRIPTION	4
2. QUICK REFERENCE GUIDE	4
3. ELECTRICAL PERFORMANCE	5
4. MECHANICAL CHARACTERISTICS.....	9
5. ASSEMBLY PROCESS.....	11
6. PACKAGING	13
7. PRODUCT CHANGE NOTIFICATION.....	14

TABLE OF CONTENTS

1. ANTENNA DESCRIPTION	4
2. QUICK REFERENCE GUIDE	4
3. ELECTRICAL PERFORMANCE	5
3.1. EVALUATION BOARD.....	5
3.2. MATCHING NETWORK.....	5
3.3. RADIATION PATTERNS AND GAIN	7
3.4. CAPABILITIES AND MEASUREMENT SYSTEMS	8
4. MECHANICAL CHARACTERISTICS.....	9
4.1. DIMENSIONS AND TOLERANCES	9
4.2. SPECIFICATIONS FOR THE INK.....	9
4.3. ANTENNA FOOTPRINT	10
5. ASSEMBLY PROCESS.....	11
6. PACKAGING	13
7. PRODUCT CHANGE NOTIFICATION.....	14

1. ANTENNA DESCRIPTION

The TVNext™ is an off-the-shelf internal antenna solution specifically designed for general handheld devices and applications operating in the FM band.

TVNext™ minimizes your product development cost and time. With its compact size and high performance, the TVNext™ internal antenna is the optimal choice for your portable FM application.

With its superior performance, small form factor, modularity and high isolation, the TVNext™ antenna solution meets and exceeds all your customer requirements for an internal compact and modular antenna.



Material: The TVNext™ antenna is built on glass epoxy substrate.

APPLICATIONS

- Mobile Phones
- Personal Media Player (PMP)
- Ultra Mobile PC (UMPC)
- Laptops

BENEFITS

- Reduced Form Factor
- Modularity - SMD
- Superior Performance
- Easy to use (pick and place)

2. QUICK REFERENCE GUIDE

Technical Features	180 – 220 MHz
Gain Curve	See page 7
Radiation Pattern	Omnidirectional
Polarization	Linear
Flatness	< 2 dB gain variation
Weight (approx.)	0.6 g
Temperature	-40 to +125° C
Impedance	50 Ω
Dimensions (L x W x H)	20.0 mm x 10.0 mm x 1.6 mm

Table 1 – Technical Features. Measures from the evaluation board. See Figure 1.

Please contact support@fractusantennas.com if you require additional information on antenna integration or optimization on your PCB.

3. ELECTRICAL PERFORMANCE

3.1. EVALUATION BOARD

The configuration used in testing the TVNext™ antenna is displayed in Figure 1.

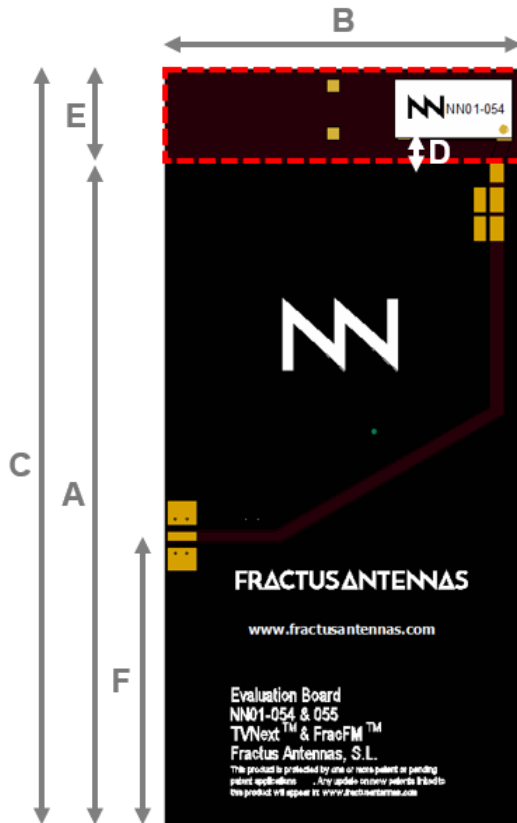

Measure	mm
A	112
B	60
C	128
D	4.1
E	16
F	47.5

Tolerance: ±0.2mm

D: Distance between the TVNext™ chip antenna component and the ground plane.

Material: The evaluation board is built on laminated substrate 1.0 mm thick (2 layers).

Clearance Area: 16 mm x 60 mm (ExB)

Figure 1 – EB_NN01-054. TVNext™ Evaluation Board.

3.2. MATCHING NETWORK

The specs of a Fractus Antennas standard antenna are measured in their evaluation board, which is an ideal case. In a real design, components nearby the antenna, LCD's, batteries, covers, connectors, etc. affect the antenna performance. This is the reason why it is highly recommended placing pads compatible with 0402 and 0603 SMD components for a PI matching network as close as possible to the antenna feeding point. Do it in the ground plane area, not in the clearance area. This is a degree of freedom to tune the antenna once the design is finished and considering all elements of the system (batteries, displays, covers, etc.).

Please notice that different devices with different ground planes and different components nearby the TVNext™ chip antenna may need a different matching network. To ensure optimal results, the use of high Q and tight tolerance components is highly recommended (Murata components). If you need assistance to design your matching network beyond this application note, please contact support@fractusantennas.com, or try our free-of-charge¹ **NN Wireless Fast-Track** design service, you will get your chip antenna design including a custom matching network for your device in 24h¹. Other related to NN's range of R&D services is available at: <https://www.fractusantennas.com/rdservices/>

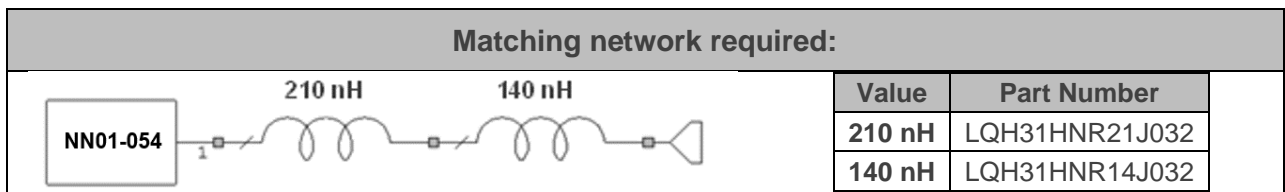

Figure 2 – Matching network implemented in the Evaluation Board.

¹ See terms and conditions for a free NN Wireless Fast-Track service in 24h at: <https://www.fractusantennas.com/fast-track-project/>

3.3. RADIATION PATTERNS AND GAIN

GAIN	 <p>Note: Please notify that this antenna is designed for reception.</p>
Radiation Pattern	
Radiation Pattern	 <p style="text-align: center;">200 MHz</p>

Table 2 – Typical antenna Gain across VHF bandwidth.

3.4. CAPABILITIES AND MEASUREMENT SYSTEMS

Fractus Antennas specializes in the design and manufacture of optimized antennas for wireless applications, and with the provision of RF expertise to a wide range of clients. We offer turn-key antenna products and antenna integration support to minimize your time requirements and maximize return on investment throughout the product development process. We also provide our clients with the opportunity to leverage our in-house testing and measurement facilities to obtain accurate results quickly and efficiently.

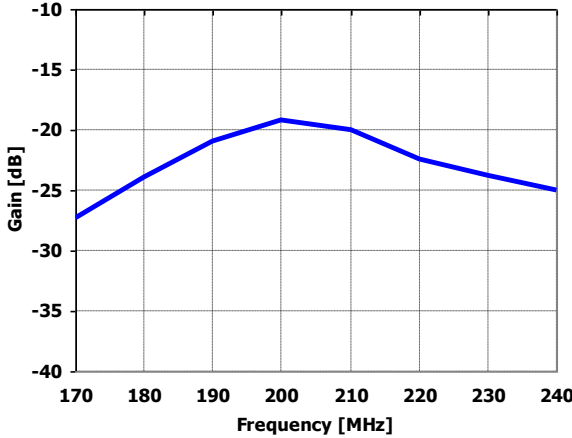
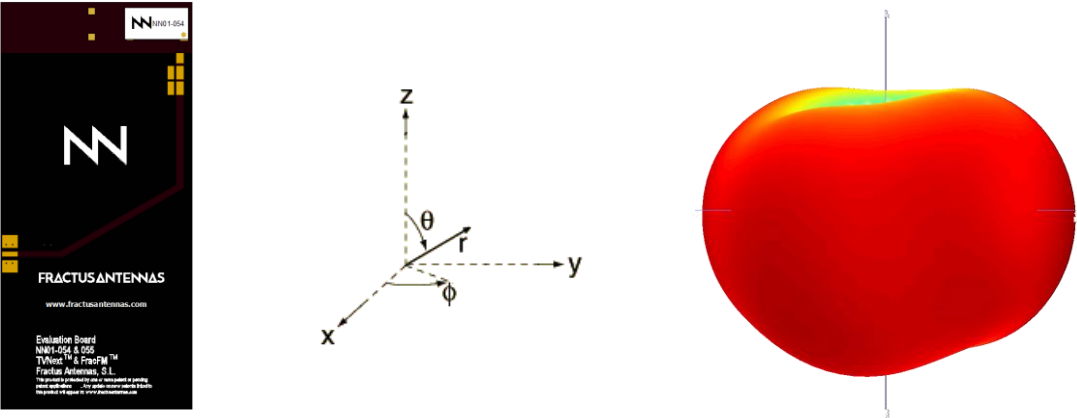
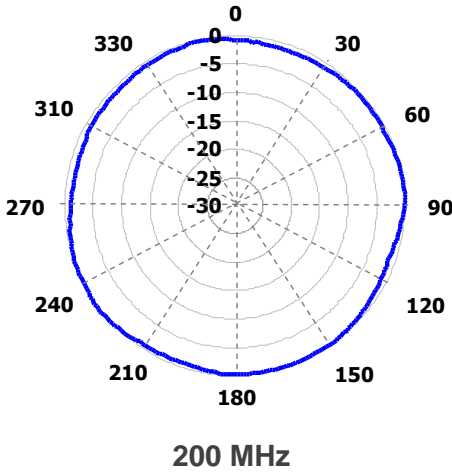
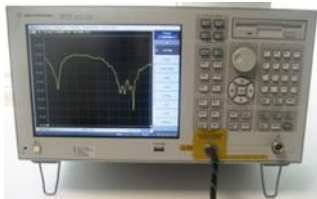

Agilent E5071B

VSWR
&
S Parameters

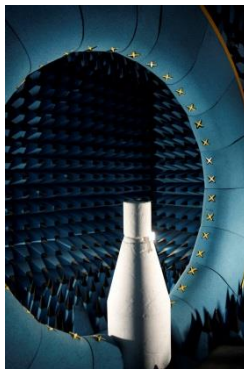
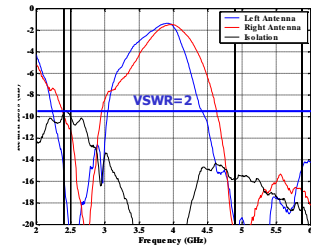

SATIMO STARGATE 32

Radiation
Pattern
&
Efficiency

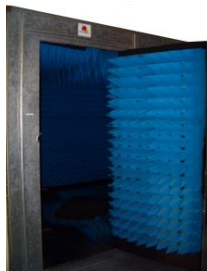
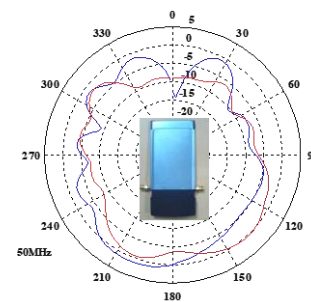

Anechoic chambers and full equipped in-house lab

4. MECHANICAL CHARACTERISTICS

4.1. DIMENSIONS AND TOLERANCES

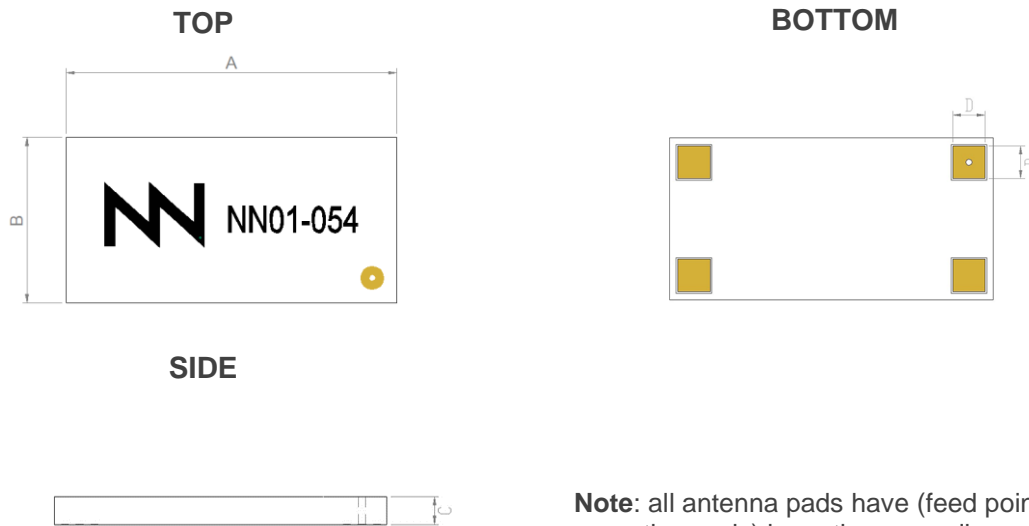

Note: all antenna pads have (feed point and mounting pads) have the same dimensions.

The yellow hole located on the front of the antenna provides a visual cue to mounting the antenna. It is located above the feed point of the antenna and is included to decrease possible manufacturing error.

Measure	mm	Measure	mm
A	20.0 ± 0.2	C	1.6 ± 0.2
B	10.0 ± 0.2	D	2.0 ± 0.1

Figure 3 – Antenna Dimensions and Tolerances.

The TVNext™ VHF antenna is compliant with the restriction of the use of hazardous substances (RoHS).

4.2. SPECIFICATIONS FOR THE INK

Next figure shows the correct colors of the antenna:

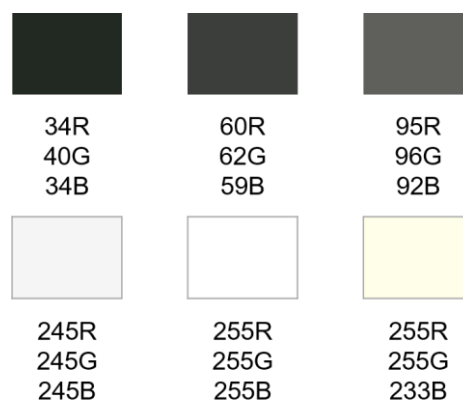

Acceptable color range

4.3. ANTENNA FOOTPRINT

This antenna footprint applies for the reference evaluation board described on page 5 of this User Manual.

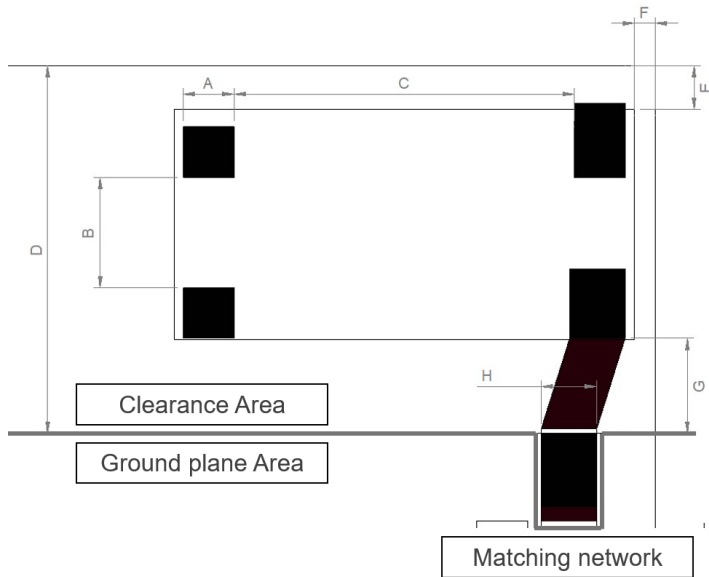

Measure	mm
A	2.0
B	5.0
C	15.0
D	16.0
E	1.9
F	0.9
G	4.1

Tolerance: ±0.2 mm

Note: all the soldering pads (feed point and mounting pads) on the antenna layout have the same dimensions.

Figure 4 – Antenna Footprint Details.

Other PCB form factors and configurations may require a different feeding configuration, feeding line dimensions and clearance areas. If you require support for the integration of the antenna in your design, please contact support@fractusantennas.com.

5. ASSEMBLY PROCESS

Figure 5 shows the back and front view of the TVNext™ VHF antenna, and indicates the location of the feeding point and the mounting pads:

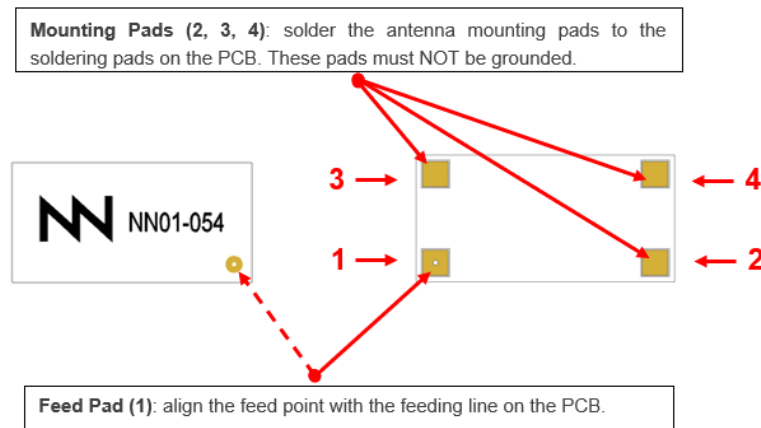

Figure 5 – Pads of the TVNext™ VHF chip antenna.

As a surface mount device (SMD), this antenna is compatible with industry standard soldering processes. The basic assembly procedure for this antenna is as follows:

1. Apply a solder paste to the pads of the PCB. Place the antenna on the board.
2. Perform a reflow process according to the temperature profile detailed in Table 3, Figure 7 on page 12.
3. After soldering the antenna to the circuit board, perform a cleaning process to remove any residual flux. Fractus Antennas recommends conducting a visual inspection after the cleaning process to verify that all reflux has been removed.

The drawing below shows the soldering details obtained after a correct assembly process:

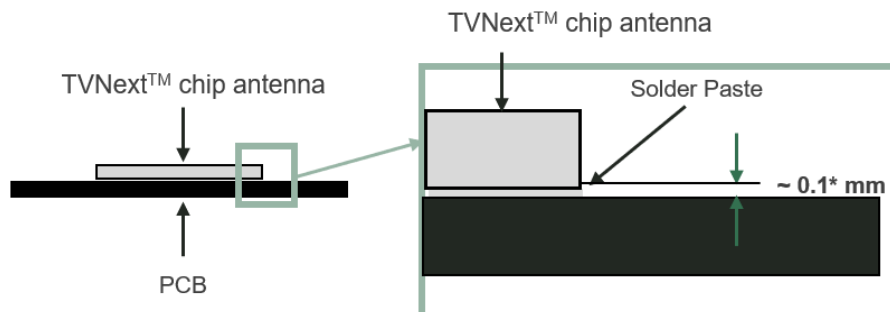

Figure 6 – Soldering Details.

NOTE(*): Solder paste thickness after the assembly process will depend on the thickness of the soldering stencil mask. A stencil thickness equal to or larger than **127 microns (5 mils)** is required.

The TVNext™ VHF antenna should be assembled following either Sn-Pb or Pb-free assembly processes. According to the Standard **IPC/JEDEC J-STD-020C**, the temperature profile suggested is as follows:

Phase	Profile features	Pb-Free Assembly (SnAgCu)
RAMP-UP	Avg. Ramp-up Rate (T _{smax} to T _p)	3 °C / second (max.)
PREHEAT	<ul style="list-style-type: none"> - Temperature Min (T_{smin}) - Temperature Max (T_{smax}) - Time (t_{smin} to t_{smax}) 	150 °C 200 °C 60-180 seconds
REFLOW	<ul style="list-style-type: none"> - Temperature (T_L) - Total Time above T_L (t_L) 	217 °C 60-150 seconds
PEAK	<ul style="list-style-type: none"> - Temperature (T_p) - Time (t_p) 	260 °C 20-40 seconds
RAMP-DOWN	Rate	6 °C/second max
Time from 25 °C to Peak Temperature		8 minutes max

Table 3 – Recommended soldering temperatures.

Next graphic shows temperature profile (grey zone) for the antenna assembly process in reflow ovens.

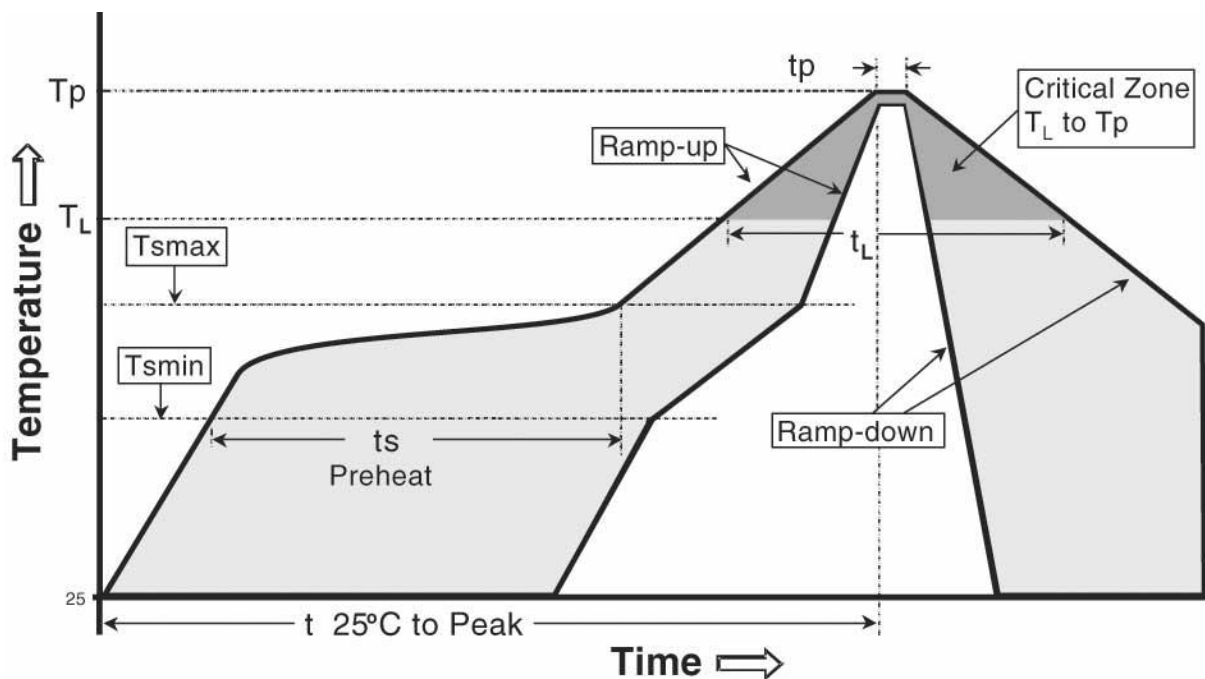
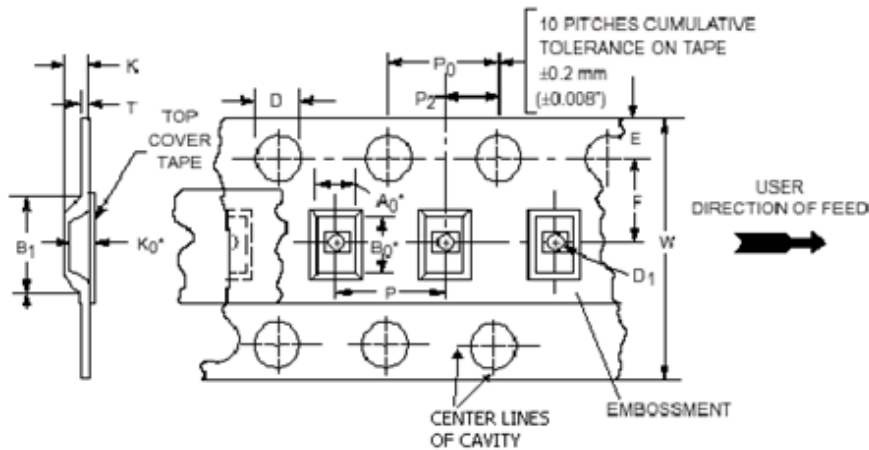

Figure 7 – Temperature profile.

6. PACKAGING

The TVNext™ chip antenna is available in tape and reel packaging.



Measure	mm
W	32.0
A0	11.5
B0	22.0
K0	1.8
B1	22.0 max
D	1.6
D1	2.1 min
Wmax	32.3
E	1.5
F	14.2
K	2.1 max
P	16.5
P0	4.5
P2	2.0

Tolerance: ±0.2mm

Figure 8 – Tape Dimensions.

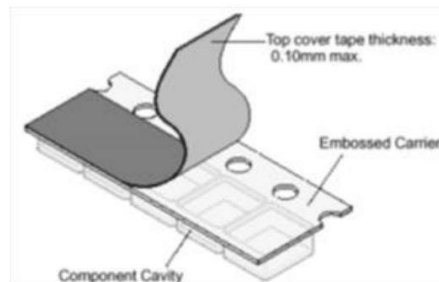
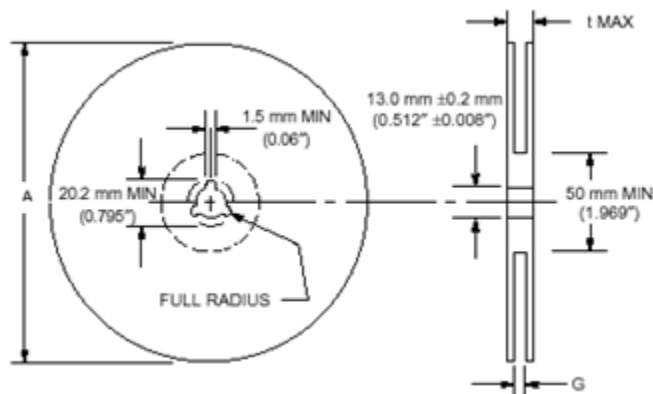

Figure 9 – Image of the tape.



Measure	mm
A max	330.0
G	32.4
t max	38.4

Tolerance: ±0.2 mm

Reel Capacity: 2000 antennas

Figure 10 – Reel Dimensions and Capacity.

7. PRODUCT CHANGE NOTIFICATION

This document is property of FRACTUS ANTENNAS,
Not to disclose or copy without prior written consent

PCN Number: NN19100008

Notification Date: October 07th, 2019

Part Number identification:

Part Number changes, it will be applied in all the document of the company (User Manual, Data Sheet, ...)

Previous Part Number	New Part Number
FR01-B3-V-0-054	NN01-054

Reason for change:

<input type="checkbox"/>	Specs (electrical/mechanical)	<input type="checkbox"/>	Manufacturing location
<input type="checkbox"/>	User Manual/Data Sheet	<input type="checkbox"/>	Quality/Reliability
<input type="checkbox"/>	Material/Composition	<input type="checkbox"/>	Logistics
<input type="checkbox"/>	Processing/Manufacturing	<input checked="" type="checkbox"/>	Other: Logo, product color and Part Number

Change description

- 1.- Part Number: From FR01-B3-V-0-054 FRACTUS to NN01-054 FRACTUS ANTENNAS in the User Manual
- 2.- Color: From blue/white to white/black



Comments:

- 1.- Electrical and Mechanical specs remain the same
- 2.- Footprint in the PCB to solder the chip antenna remains the same

Identification method

- 1.- In the chip antennas, the changes are in the color, in the logo and in the part number

User Manual	<input checked="" type="checkbox"/>	Available from: May 2020
Samples	<input checked="" type="checkbox"/>	Available from: January 2021

FRACTUS ANTENNAS Contact:

Sales
Name: Josep Portabella
Email: josep.portabella@fractusantennas.com

Supply Chain
Albert Vidal
albert.vidal@fractusantennas.com