

5G TINY ANTENNA FOR IOT WITH NO CLEARANCE BEYOND THE FOOTPRINT

- **Antenna Component:** DUO mXTEND™ NN03-320
- **Dimensions:** 7.0 mm x 3.0 mm x 2.0 mm
- **Frequency regions:** 3.4 GHz to 3.8 GHz

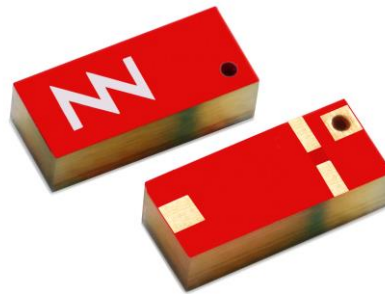

This is DUO mXTEND™, the tiny antenna booster that enables full **5G connectivity** and **does not require further clearance area than its reduced footprint**.

Forget the clearance troubles on your next **5G** wireless design, DUO mXTEND™ doesn't need any clearance beyond its footprint. This new antenna booster is **modular, multipurpose** and **multi-port** and enables **top-quality high-speed connectivity to IoT and Mobile devices using 5G**. It is fully **reconfigurable**, so it can be mounted either at the corner or at the center edge of your 5G device, thanks to this modular and **dual port** nature.

This antenna booster has been designed for providing a **top-quality mobile operation at 3400-3800 MHz**, regardless of the antenna position on your device, either if the mounting of the component is at a corner of the PCB or just at the center edge of the printed circuit board.

Doesn't matter the size or form factor of your next wireless device, DUO mXTEND™ fits in about all of them because is tiny, **only 7.0 x 3.0 x 2.0 mm**. Since the device does not need any clearance on the PCB ground beyond its antenna footprint, you can use the proximity area in the component to arrange other element in the PCB. And since the performance of the antenna component is optimized whether you are mounting it on a device corner or at the center edge, DUO mXTEND™ provides maximum flexibility to the RF designer, whether he is struggling with limited space inside a 5G device or he needs to arrange multiple antennas on several locations for MIMO operation. With DUO mXTEND™, upgrading your 5G device to the 3400-3800 MHz will be fast and easy!

TABLE OF CONTENTS

1.	PRODUCT DESCRIPTION NN03-320.....	3
2.	EVALUATION BOARD 5G.....	4
2.1.	QUICK REFERENCE GUIDE	4
2.2.	EVALUATION BOARD.....	4
2.3.	MATCHING NETWORK.....	5
2.4.	VSWR AND TOTAL EFFICIENCY	6
2.5.	RECOMMENDED ANTENNA FOOTPRINT FOR NN03-320	6
2.6.	RADIATION PATTERNS (3.4, 3.6 and 3.8 GHz), GAIN, AND EFFICIENCY.....	7

1. PRODUCT DESCRIPTION NN03-320

The DUO mXTEND™ antenna booster has been specifically designed for providing 5G (sub 6GHz) performance in wireless devices with **small space** requirements. It presents **high antenna efficiency** values. Also, the DUO mXTEND™ antenna booster does **not** require further **clearance area beyond** its 7 mm x 3 mm **footprint**. Moreover, it has two feeding ports allowing the **integration at the corner** or at the **center edge** of your device depending which port is excited. In particular, this application note illustrates how to use it for operating at 5G: **3.4GHz-3.8GHz**

Finally, if you are designing a **different device size** or a **different band of the sub-6GHz spectrum between 3.3GHz to 5GHz**, we can assist you in less than 24 hours. Please, use our free of charge NN Wireless Fast Track service at: <https://www.fractusantennas.com/fast-track-project/>

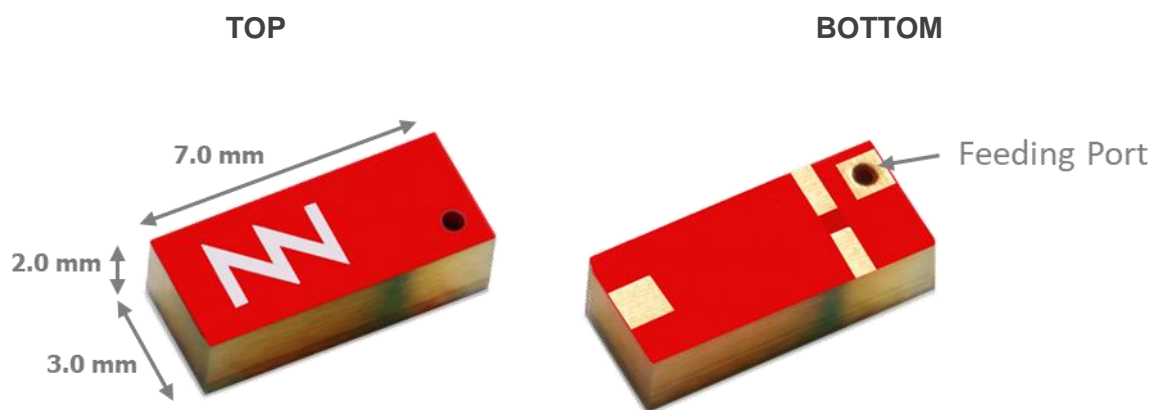

Material: The DUO mXTEND™ antenna booster is built on glass epoxy substrate.

APPLICATIONS

- IoT devices
- Smart metering
- Smart city
- Smart agriculture
- Smart home
- Sensors

BENEFITS

- High efficiency
- Small size
- Cost-effective
- Easy-to-use (pick and place)
- Off-the-Shelf Product (no customization is required)

The DUO mXTEND™ antenna booster belongs to a new generation of antenna solutions based on Virtual Antenna™ technology owned by FRACTUS ANTENNAS. The technology is focused on replacing conventional antenna solutions by miniature and off-the-shelf components.

2. EVALUATION BOARD 5G

2.1. QUICK REFERENCE GUIDE

Technical features	3.4 – 3.8 GHz
Average Efficiency	> 60%
Peak Gain	2.6 dBi
VSWR	< 3.0:1
Radiation Pattern	Omnidirectional
Polarization	Linear
Weight (approx.)	0.11 g.
Temperature	-40 to + 125 °C
Impedance	50 Ω
Dimensions (L x W x H)	7.0 mm x 3.0 mm x 2.0 mm

Table 1 – Technical Features. Measures from the Evaluation Board. See Figure 1.

2.2. EVALUATION BOARD

This Evaluation Board EB_NN03-320-m-5G integrates a UFL cable to connect the DUO mXTEND™ antenna booster with the SMA connector. The DUO mXTEND™ provides operation in the frequency region going from 3.4 GHz to 3.8 GHz (5G band), through a single input/output port.

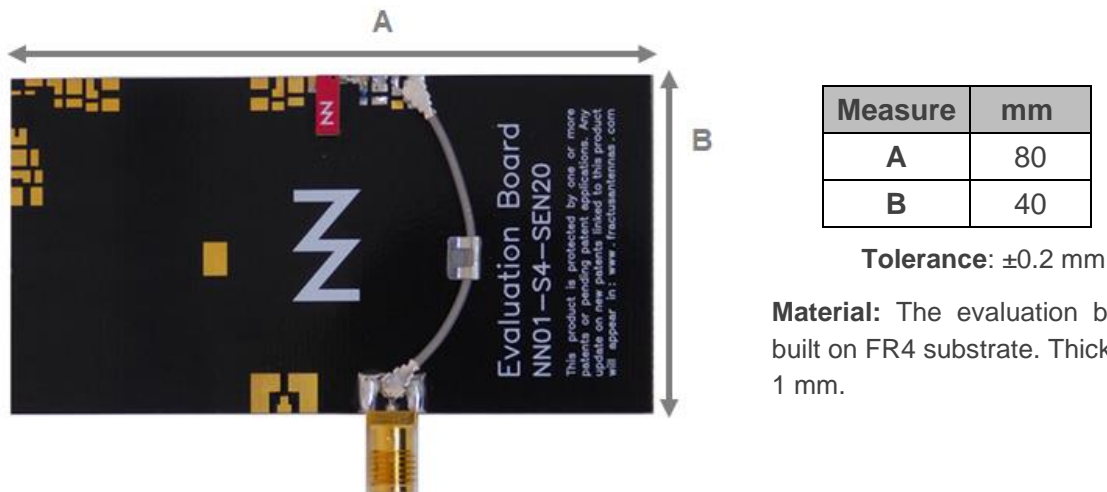

Figure 1 – EB_NN03-320-m-5G. Evaluation Board providing operation at 5G band (from 3.4 GHz to 3.8 GHz). Notice that the clearance area is equal to the DUO mXTEND™ footprint.

This product and/or its use is protected by at least one or more of the following patents and patent applications US 62,777,835, EP 18211745.7, US 15,835,007; and other domestic and international patents pending. Additional information about patents related to this product is available at www.fractusantennas.com/virtual-antenna/.

2.3. MATCHING NETWORK

The antenna performance is always conditioned by its operating environment. Different devices with different printed circuit board sizes, components nearby the antenna, LCD's, batteries, covers, connectors, etc. affect the antenna performance. Accordingly, it is highly recommended placing pads compatible with 0402 and 0603 SMD components for a matching network as close as possible to the feeding point of the antenna element. Do it in the ground plane area, not in the clearance area. This provides a degree of freedom to tune the DUO mXTEND™ antenna booster once the design is finished and taking into account all elements of the system (batteries, displays, covers, etc.).

This section will present the proposed matching network and specs measured in the corresponding evaluation board (Figure 1), which is an ideal case. Please note that different devices with different ground planes and different components nearby the DUO mXTEND™ antenna booster may need a different matching network. To ensure optimal results, the use of high-quality factor (Q) and tight tolerance components is highly recommended (e.g. Murata components (Figure 2)).

If you need assistance to design your matching network beyond this application note, please contact support@fractusantennas.com, or try our free-of-charge¹ **NN Wireless Fast-Track** design service, you will get your chip antenna design including a custom matching network for your device in 24h¹. Other related to NN's range of R&D services is available at: <https://www.fractusantennas.com/rdservices/>

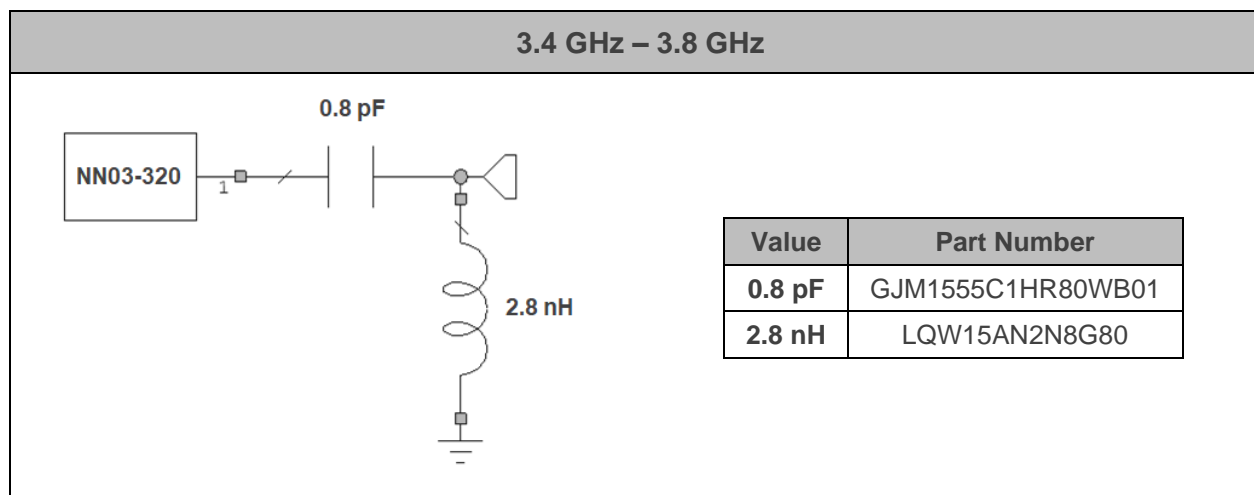

Figure 2 – Matching Network implemented in the evaluation board (Figure 1).

¹ See terms and conditions for a free NN Wireless Fast-Track service in 24h at: <https://www.fractusantennas.com/fast-track-project/>

2.4. VSWR AND TOTAL EFFICIENCY

VSWR (Voltage Standing Wave Ratio) and Total Efficiency versus Frequency (GHz).

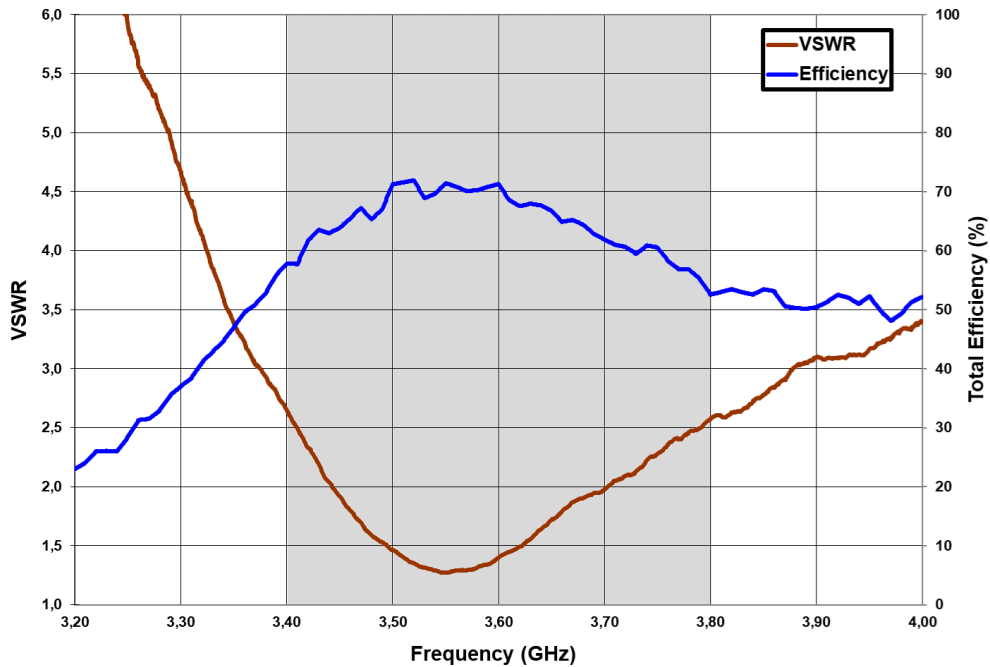

Figure 3 – VSWR and Total Efficiency for 5G band (3.4 – 3.8 GHz) from the evaluation board Figure 1.

2.5. RECOMMENDED ANTENNA FOOTPRINT FOR NN03-320

Assuming that the DUO mXTEND™ antenna booster (NN03-320) is placed in the middle of the PCB, see below the recommended footprint dimensions.

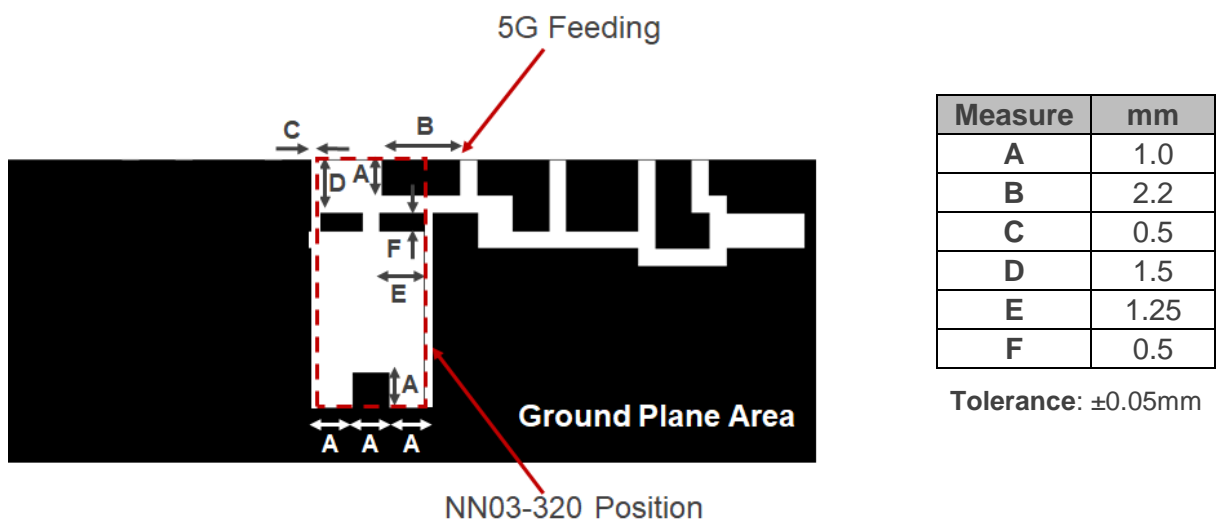
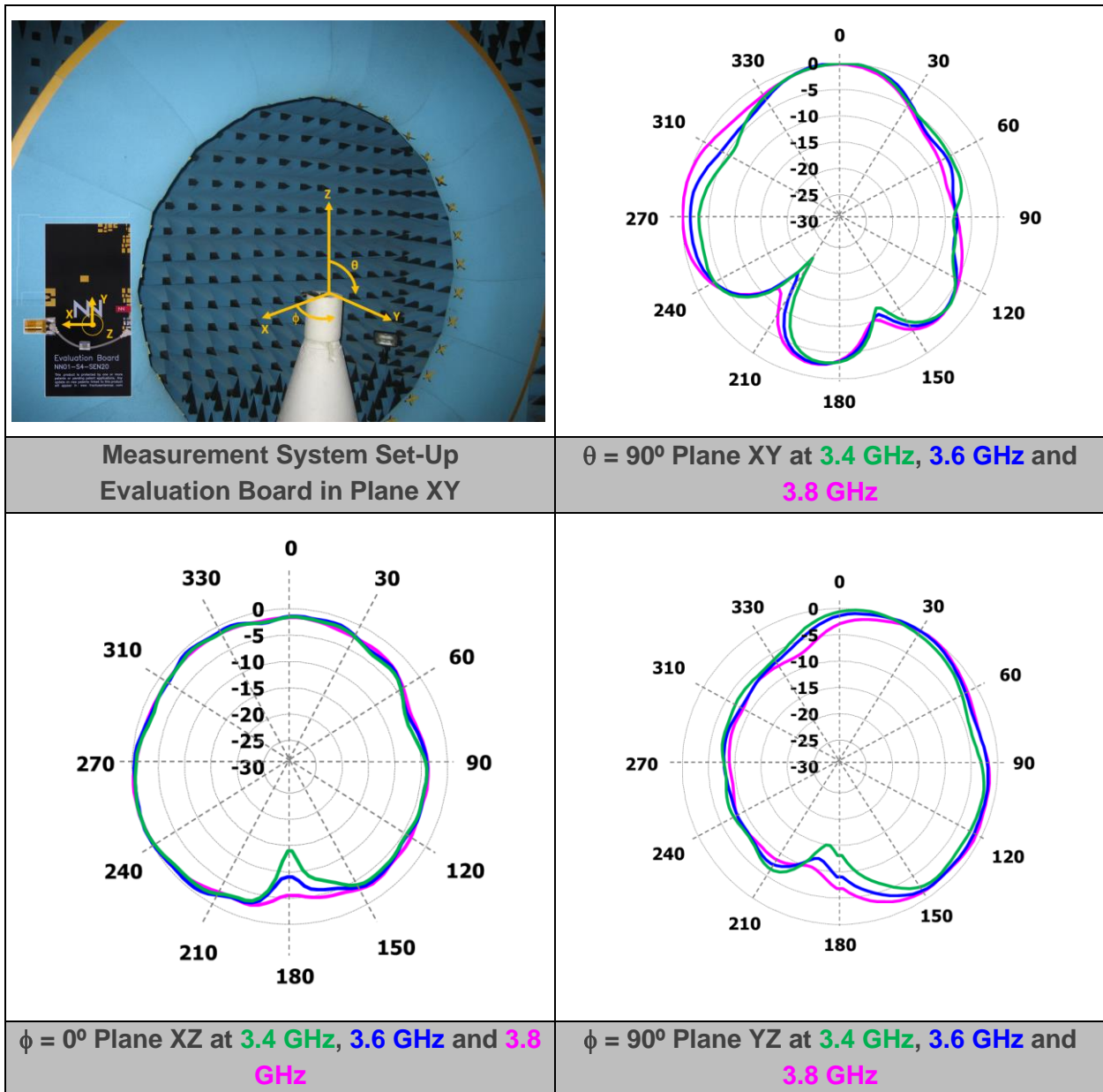

Figure 4 – Footprint dimensions for the NN03-320 in the middle for 5G.

For additional support in the integration process, please contact support@fractusantennas.com.

2.6. RADIATION PATTERNS (3.4, 3.6 and 3.8 GHz), GAIN, AND EFFICIENCY



5G	Gain	Peak Gain	2.6 dBi
		Average Gain across the band	2.2 dBi
		Gain Range across the band (min, max)	1.7 <-> 2.6 dBi
	Efficiency	Peak Efficiency	71.9 %
		Average Efficiency across the band	64.9 %
		Efficiency Range across the band (min, max)	52.55 – 71.9 %

Table 2 – Antenna Gain and Total Efficiency from the evaluation board (Figure 1) for 3.4GHz-3.8GHz band. Measures made in the Satimo STARGATE 32 anechoic chamber.

Fractus Antennas products are protected by [Fractus Antennas patents](#).

All information contained within this document is property of Fractus Antennas and is subject to change without prior notice. Information is provided “as is” and without warranties. It is prohibited to copy or reproduce this information without prior approval.

Fractus Antennas is an ISO 9001:2015 certified company. All our antennas are lead-free and RoHS compliant.

ISO 9001: 2015 Certified

