

RUN mXTEND™ (NN02-224) – AN for WiFi Dual-band 2.4-2.5 GHz and 4.9-5.875 GHz

Fractus Antennas specializes in enabling effective mobile communications. Using Fractus Antennas technology, we design and manufacture optimized antennas to make your wireless devices more competitive. Our mission is to help our clients develop innovative products and accelerate their time to market through our expertise in antenna design, testing and manufacturing.



RUN mXTEND™ antenna booster
NN02-224

Fractus Antennas products are protected by [Fractus Antennas patents](#).

All information contained within this document is property of Fractus Antennas and is subject to change without prior notice. Information is provided “as is” and without warranties. It is prohibited to copy or reproduce this information without prior approval.

Fractus Antennas is an ISO 9001:2015 certified company. All our antennas are lead-free and RoHS compliant.

ISO 9001: 2015

TABLE OF CONTENTS

1.	PRODUCT DESCRIPTION NN02-224.....	3
2.	EVALUATION BOARD WIFI DUAL-BAND	4
2.1.	QUICK REFERENCE GUIDE	4
2.2.	EVALUATION BOARD.....	4
2.3.	MATCHING NETWORK.....	5
2.4.	VSWR AND TOTAL EFFICIENCY	6
2.5.	RADIATION PATTERNS (2.4-2.5 GHz), GAIN AND EFFICIENCY	7
2.6.	RADIATION PATTERNS (4.9-5.875 GHz), GAIN AND EFFICIENCY	8
3.	EVALUATION BOARD CR80 WIFI DUAL-BAND	9
3.1.	QUICK REFERENCE GUIDE	9
3.2.	EVALUATION BOARD.....	9
3.3.	MATCHING NETWORK.....	10
3.4.	VSWR AND TOTAL EFFICIENCY	11
3.5.	RADIATION PATTERNS (2.4-2.5 GHz), GAIN AND EFFICIENCY	12
3.6.	RADIATION PATTERNS (4.9-5.875 GHz), GAIN AND EFFICIENCY	13

1. PRODUCT DESCRIPTION NN02-224

The RUN mXTEND™ antenna booster has been specifically designed for providing multiband performance in wireless devices (in particular in mobile devices), enabling worldwide coverage by allowing operation in the communication standards such as Wi-Fi Dual-band.

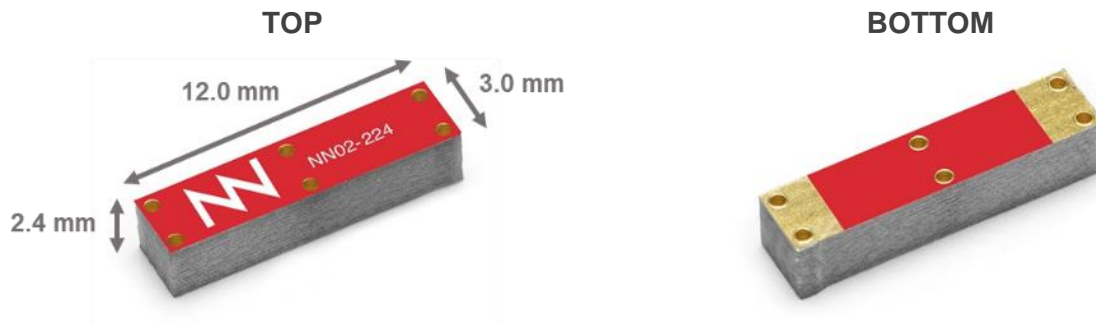

Material: The RUN mXTEND™ antenna booster is built on glass epoxy substrate.

APPLICATIONS

- Handsets and Smartphones
- Tablets and PCs
- Modules
- Routers
- Home automation

BENEFITS

- High efficiency
- Small size
- Cost-effective
- Easy-to-use (pick and place)
- Multiband behaviour (worldwide standards)
- Off-the-Shelf Standard Product (no customization is required)

The RUN mXTEND™ antenna booster belongs to a new generation of antenna solutions based on the Virtual Antenna™ technology developed by Fractus. The technology is mainly focused on replacing conventional antenna solutions by miniature and standard components.

This project has received funding from the European Union’s Horizon 2020 research and innovation programme under grant agreement N° 674491



2. EVALUATION BOARD WIFI DUAL-BAND

2.1. QUICK REFERENCE GUIDE

Technical features	2.4 – 2.5 GHz	4.9 – 5.875 GHz
Average Efficiency	> 70 %	> 70 %
Peak Gain	2.9 dBi	3.1 dBi
VSWR	< 2.5:1	
Radiation Pattern	Omnidirectional	
Polarization	Linear	
Weight (approx.)	0.19 g	
Temperature	-40 to +125 °C	
Impedance	50 Ω	
Dimensions (L x W x H)	12.0 mm x 3.0 mm x 2.4 mm	

Table 1 – Technical Features. Measures from the Evaluation Board. See Figure 1.

2.2. EVALUATION BOARD

This Evaluation Board EB_NN02-224-2,4-5 is made with a coplanar grounded transmission line (trace on the PCB) to connect the RUN mXTEND™ antenna booster with the SMA connector. The RUN mXTEND™ provides operation in the frequency regions, from 2.4 GHz to 2.5 GHz and from 4.9 GHz to 5.875 GHz, through a single input/output port.

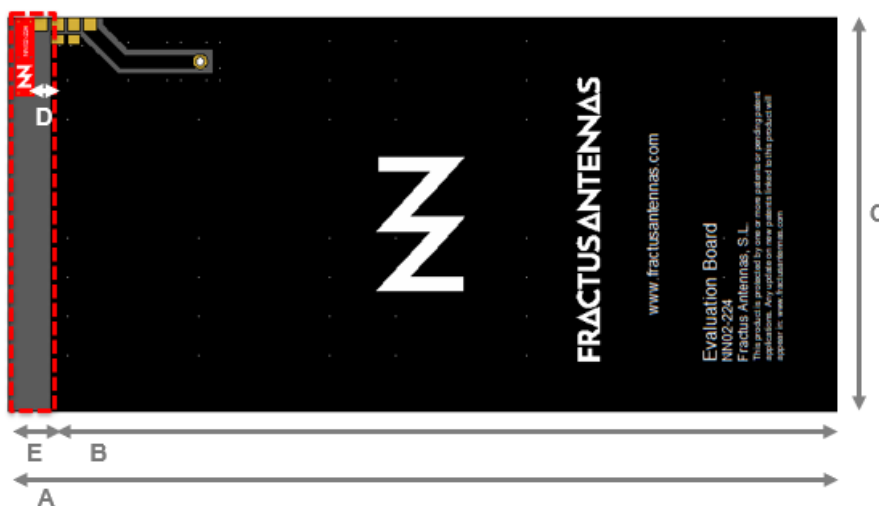

Measure	mm
A	126.5
B	120
C	60
D	2.5
E	6.5

Tolerance: ±0.2 mm

D: Distance between the RUN mXTEND™ antenna booster and the ground plane.

Material: The evaluation board is built on FR4 substrate. Thickness is 1 mm.

Clearance Area: 6.5 mm x 60 mm (E x C)

Figure 1 – EB_NN02-224-2,4-5. Evaluation Board providing operation from 2.4 GHz to 2.5 GHz and from 4.9 GHz to 5.875 GHz.

This product and its use are protected by at least one or more of the following [patents](#) PAT. US 9,130,259 B2; PAT. US 8,237,615 B2. Other domestic and international patents pending. Additional information about patents related to this product is available at www.fractusantennas.com/virtual-antenna/.

2.3. MATCHING NETWORK

The specs of a Fractus Antennas standard product are measured in their evaluation board, which is an ideal case. In a real design, components nearby the antenna, LCD's, batteries, covers, connectors, etc. affect the antenna performance. This is the reason why it is highly recommended placing pads compatible with 0402 and 0603 SMD components for a matching network as close as possible to the feeding point. Do it in the ground plane area, not in the clearance area. This provides a degree of freedom to tune the RUN mXTEND™ antenna booster once the design is finished and taking into account all elements of the system (batteries, displays, covers, etc.).

Please notice that different devices with different ground planes and different components nearby the RUN mXTEND™ antenna booster may need a different matching network. To ensure optimal results, the use of high Q and tight tolerance components is highly recommended (Murata components). Please, if you need assistance contact support@fractusantennas.com for more information related to the antenna booster matching service.

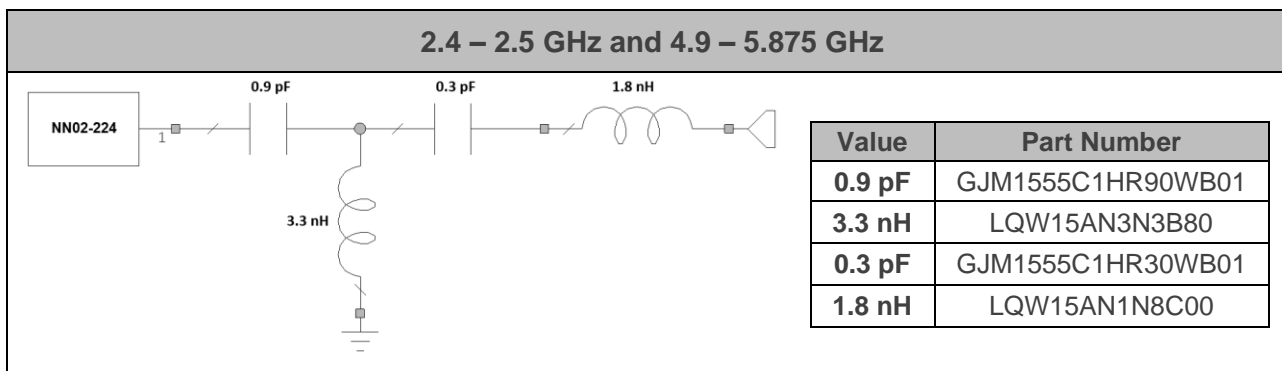

Figure 2 – Matching Network implemented in the evaluation board (Figure 1).

For additional information, please visit www.fractusantennas.com or contact info@fractusantennas.com.

If you need assistance to design your matching network, please contact support@fractusantennas.com, or try our free-of-charge¹ **NN Wireless Fast-Track** design service, you will get your chip antenna design including a custom matching network for your device in 24h¹. Other related to NN's range of R&D services is available at: <https://www.fractusantennas.com/rdservices/>

¹ See terms and conditions for a free NN Wireless Fast-Track service in 24h at: <https://www.fractusantennas.com/fast-track-project/>

2.4. VSWR AND TOTAL EFFICIENCY

VSWR (Voltage Standing Wave Ratio) and Total Efficiency versus Frequency (GHz).

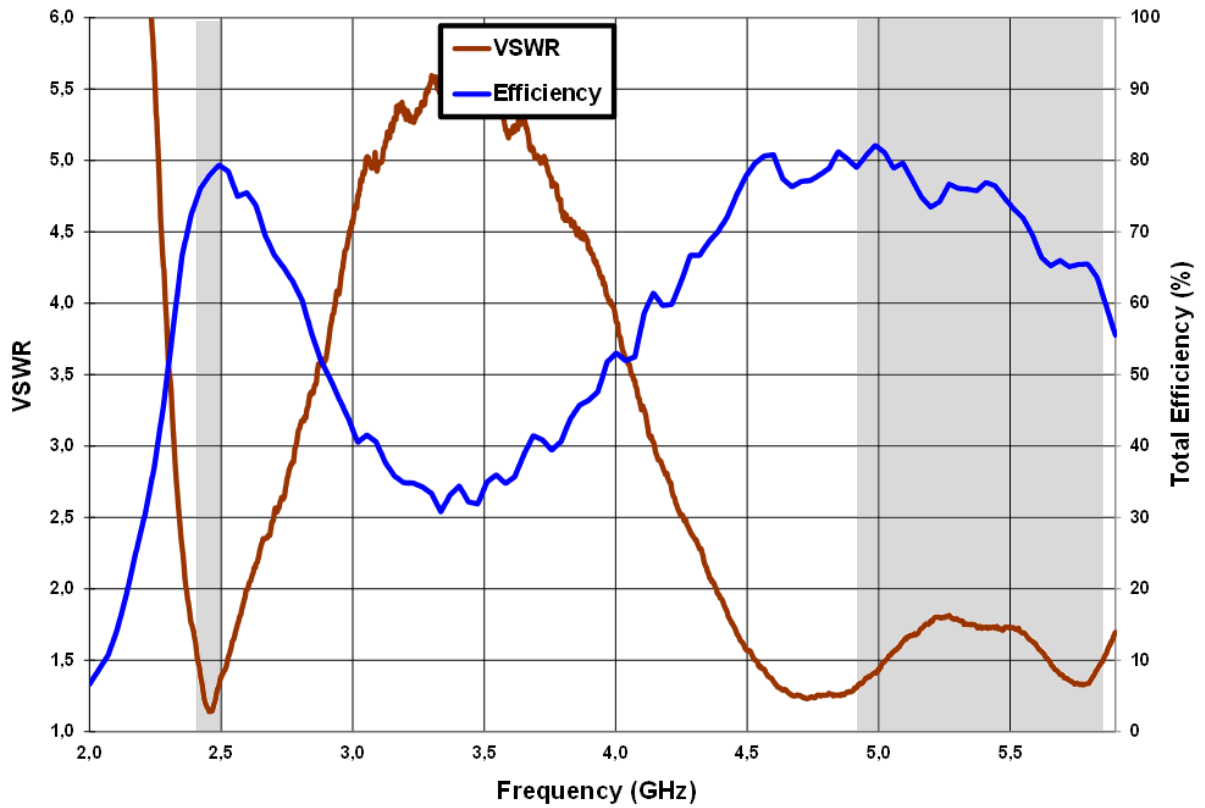
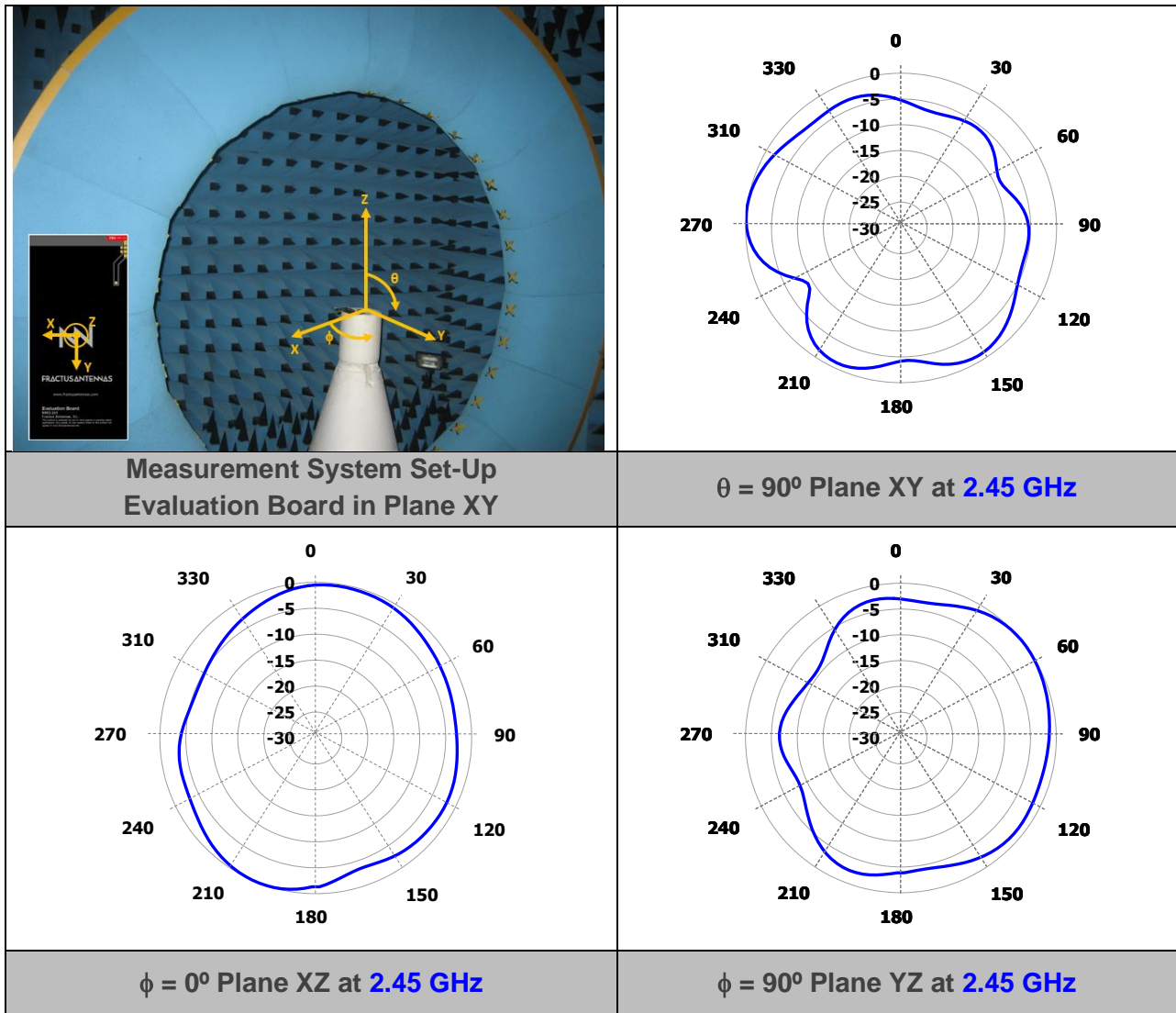

Figure 3 – VSWR and Total Efficiency for the 2.4 – 2.5 GHz frequency range and for the 4.9 – 5.875 GHz frequency range from the evaluation board (Figure 1).

2.5. RADIATION PATTERNS (2.4-2.5 GHz), GAIN AND EFFICIENCY



Gain	Peak Gain	2.9 dBi
	Average Gain across the band	2.7 dBi
	Gain Range across the band (min, max)	2.3 <-> 2.9 dBi
Efficiency	Peak Efficiency	78.9 %
	Average Efficiency across the band	75.7 %
	Efficiency Range across the band (min, max)	72.8 – 78.7 %

Table 2 – Antenna Gain and Total Efficiency from the evaluation board (Figure 1) within the 2.4 – 2.5 GHz frequency range. Measures made in the Satimo STARGATE 32 anechoic chamber.

2.6. RADIATION PATTERNS (4.9-5.875 GHz), GAIN AND EFFICIENCY

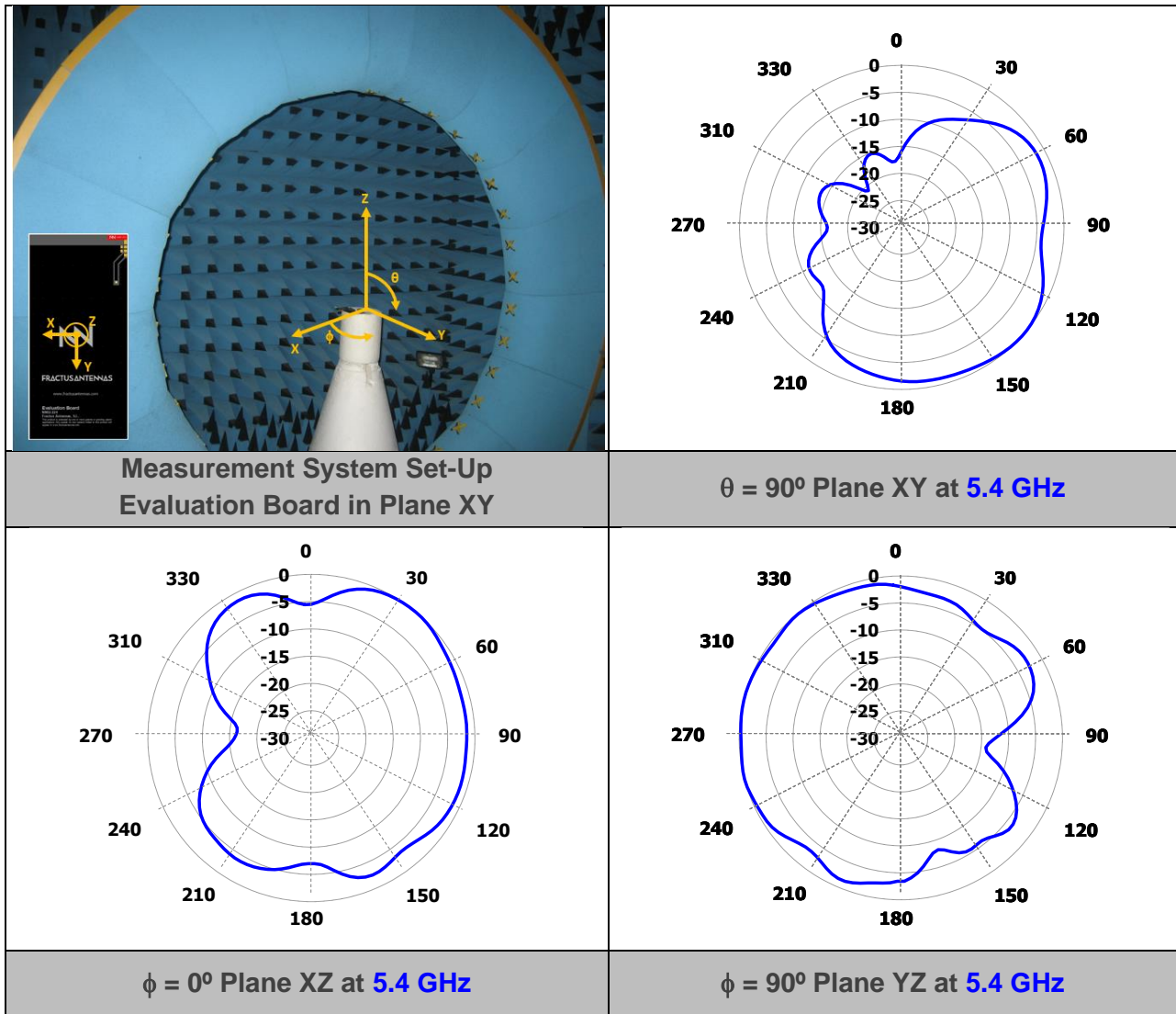

Gain	Peak Gain	3.1 dBi
	Average Gain across the band	2.8 dBi
	Gain Range across the band (min, max)	1.8 <-> 3.1 dBi
Efficiency	Peak Efficiency	83.1 %
	Average Efficiency across the band	72.8 %
	Efficiency Range across the band (min, max)	58.7 – 83.1 %

Table 3 – Antenna Gain and Total Efficiency from the evaluation board (Figure 1) within the 4.9-5.875 GHz frequency range. Measures made in the Satimo STARGATE 32 anechoic chamber.

3. EVALUATION BOARD CR80 WIFI DUAL-BAND

3.1. QUICK REFERENCE GUIDE

Technical features	2.4 – 2.5 GHz	4.9 – 5.875 GHz
Average Efficiency	> 75 %	> 65 %
Peak Gain	2.3 dBi	2.8 dBi
VSWR	< 2:1	
Radiation Pattern	Omnidirectional	
Polarization	Linear	
Weight (approx.)	0.19 g	
Temperature	-40 to +125 °C	
Impedance	50 Ω	
Dimensions (L x W x H)	12.0 mm x 3.0 mm x 2.4 mm	

Table 4 – Technical Features. Measures from the Evaluation Board. See Figure 4.

3.2. EVALUATION BOARD

This Evaluation Board EB_NN02-224-CR80-2,4-5 is made with a coplanar grounded transmission line (trace on a PCB) to connect the RUN mXTEND™ antenna booster with the SMA connector. The RUN mXTEND™ provides operation in the frequency regions, from 2.4 GHz to 2.5 GHz and from 4.9 GHz to 5.875 GHz, through a single input/output port.

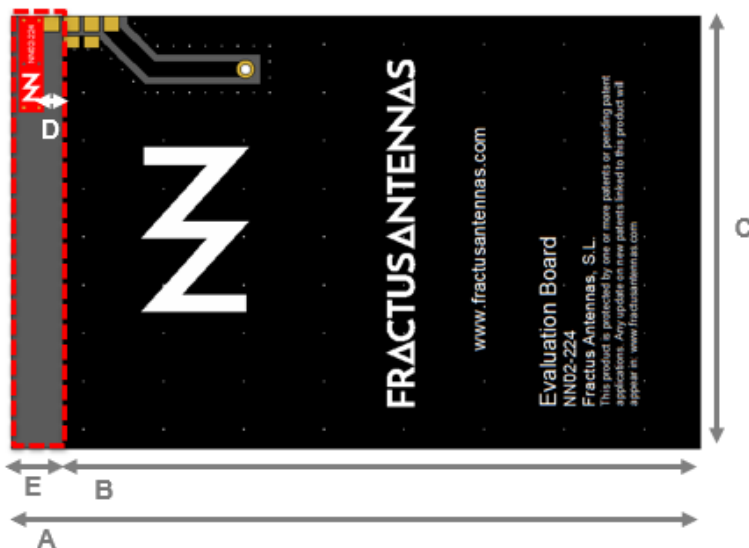

Measure	mm
A	86
B	79.5
C	54
D	2.5
E	6.5

Tolerance: ±0.2 mm

D: Distance between the RUN mXTEND™ antenna booster and the ground plane.

Material: The evaluation board is built on FR4 substrate. Thickness is 1 mm.

Clearance Area: 6.5 mm x 60 mm (E x C)

Figure 4 – EB_NN02-224-CR80-2,4-5 in CR80 standard format. Evaluation Board providing operation from 2.4 GHz to 2.5 GHz and from 4.9 GHz to 5.875 GHz.

This product and its use are protected by at least one or more of the following [patents](#) PAT. US 9,130,259 B2; PAT. US 8,237,615 B2. Other domestic and international patents pending. Additional information about patents related to this product is available at www.fractusantennas.com/virtual-antenna/.

3.3. MATCHING NETWORK

The specs of a Fractus Antennas standard product are measured in their evaluation board, which is an ideal case. In a real design, components nearby the antenna, LCD's, batteries, covers, connectors, etc. affect the antenna performance. This is the reason why it is highly recommended placing pads compatible with 0402 and 0603 SMD components for a matching network as close as possible to the feeding point. Do it in the ground plane area, not in the clearance area. This provides a degree of freedom to tune the RUN mXTEND™ antenna booster once the design is finished and taking into account all elements of the system (batteries, displays, covers, etc.).

Please notice that different devices with different ground planes and different components nearby the RUN mXTEND™ antenna booster may need a different matching network. To ensure optimal results, the use of high Q and tight tolerance components is highly recommended (Murata components). Please, if you need assistance contact support@fractusantennas.com for more information related to the antenna booster matching service.

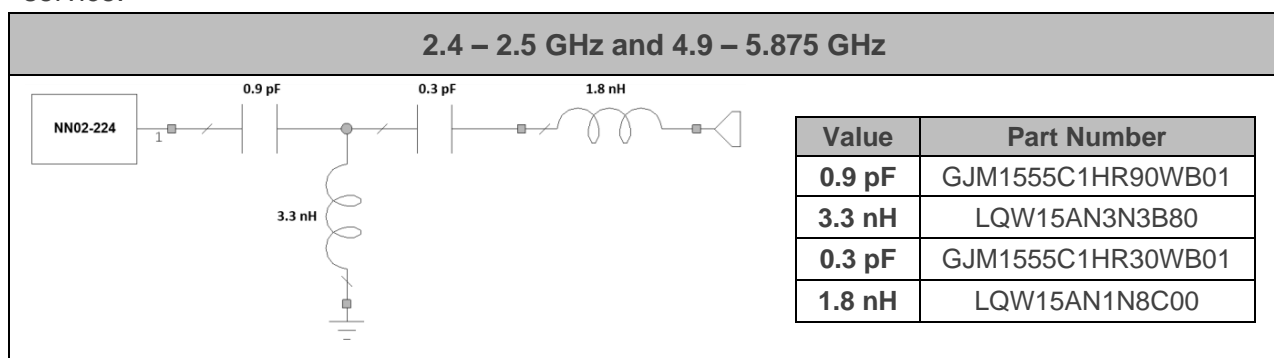

Figure 5 – Matching Network implemented in the evaluation board (Figure 4).

For additional information, please visit www.fractusantennas.com or contact info@fractusantennas.com.

If you need assistance to design your matching network, please contact support@fractusantennas.com, or try our free-of-charge² **NN Wireless Fast-Track** design service, you will get your chip antenna design including a custom matching network for your device in 24h². Other related to NN's range of R&D services is available at: <https://www.fractusantennas.com/rdservices/>

² See terms and conditions for a free NN Wireless Fast-Track service in 24h at: <https://www.fractusantennas.com/fast-track-project/>

3.4. VSWR AND TOTAL EFFICIENCY

VSWR (Voltage Standing Wave Ratio) and Total Efficiency versus Frequency (GHz).

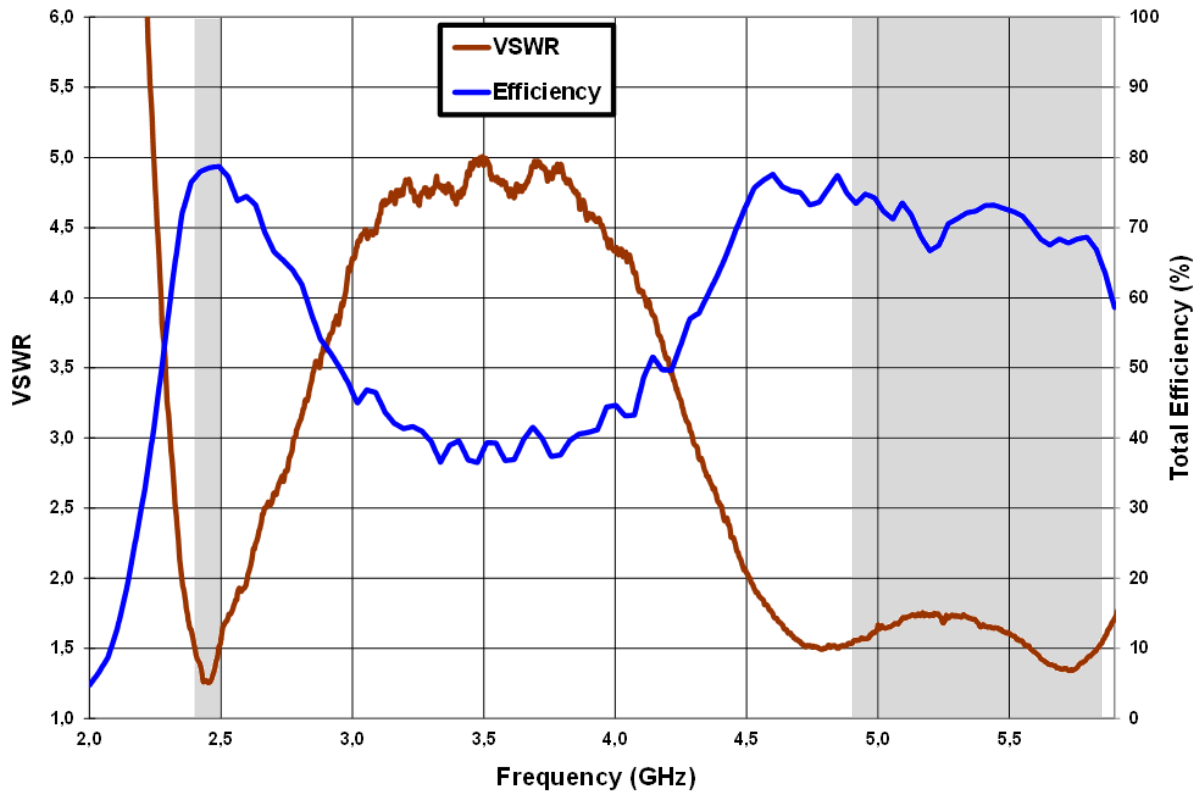
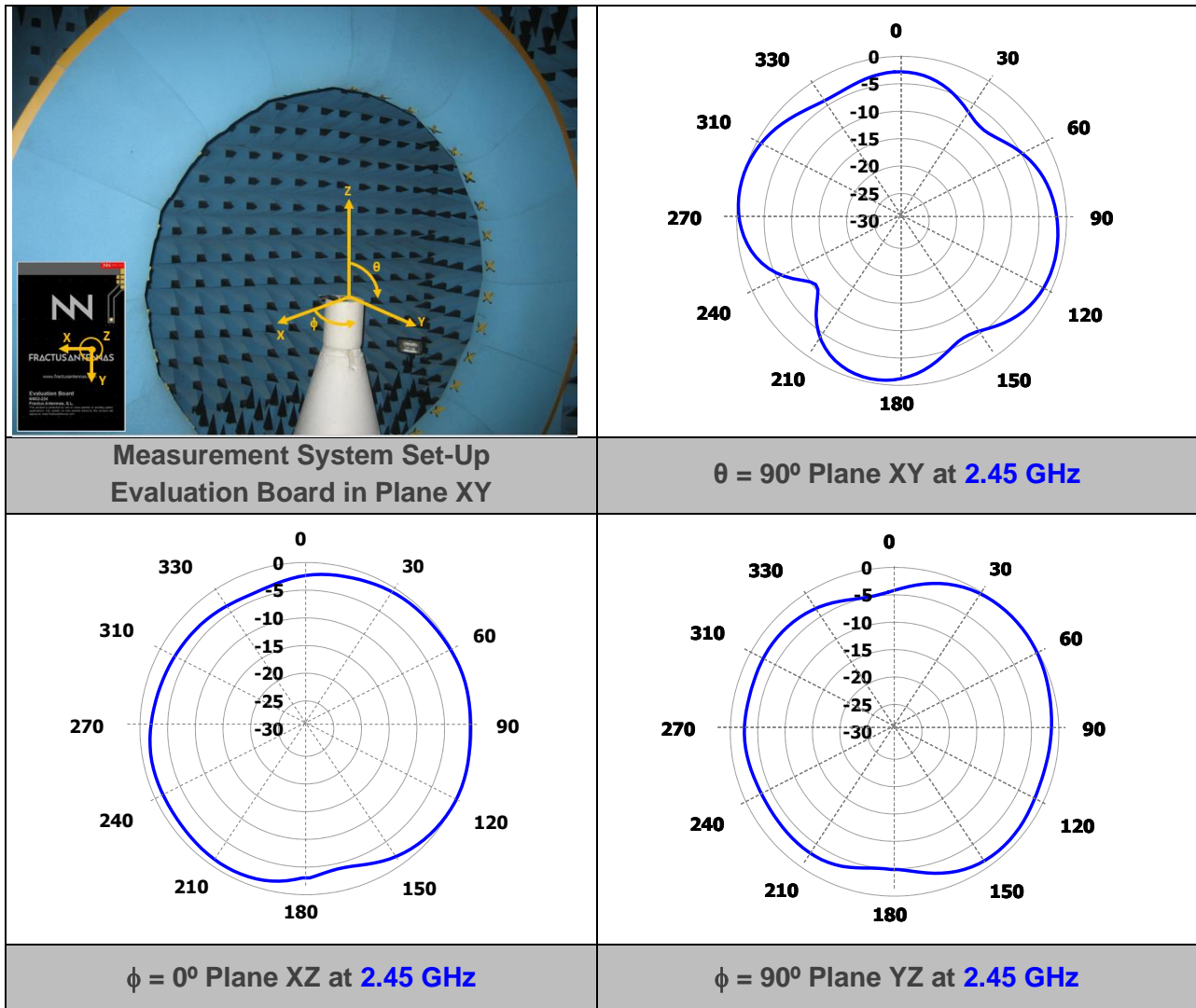

Figure 6 – VSWR and Total Efficiency for the 2.4 – 2.5 GHz frequency range and for the 4.9 – 5.875 GHz frequency range from the evaluation board (Figure 4).

3.5. RADIATION PATTERNS (2.4-2.5 GHz), GAIN AND EFFICIENCY



Gain	Peak Gain	2.3 dBi
	Average Gain across the band	2.1 dBi
	Gain Range across the band (min, max)	1.9 <-> 2.3 dBi
Efficiency	Peak Efficiency	78.7 %
	Average Efficiency across the band	78.3 %
	Efficiency Range across the band (min, max)	77.1 – 78.7 %

Table 5 – Antenna Gain and Total Efficiency from the Evaluation Board (Figure 4) within the 2.4 – 2.5 GHz frequency range. Measures made in the Satimo STARGATE 32 anechoic chamber.

3.6. RADIATION PATTERNS (4.9-5.875 GHz), GAIN AND EFFICIENCY

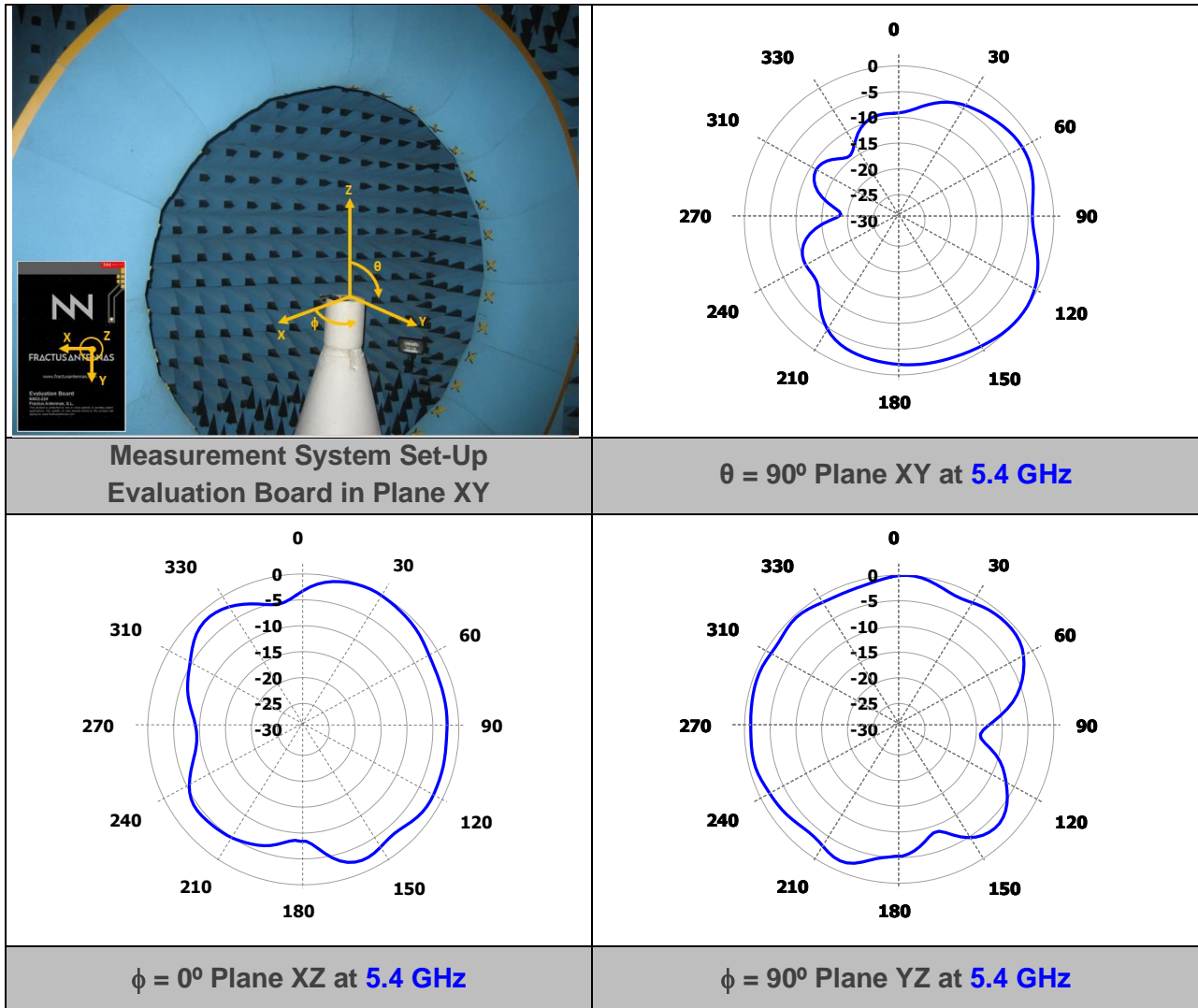

Gain	Peak Gain	2.8 dBi
	Average Gain across the band	2.4 dBi
	Gain Range across the band (min, max)	1.6 <-> 2.8 dBi
Efficiency	Peak Efficiency	74.8 %
	Average Efficiency across the band	70.5 %
	Efficiency Range across the band (min, max)	62.0 – 74.8 %

Table 6 – Antenna Gain and Total Efficiency from the evaluation board (Figure 4) within the 4.9 – 5.875 GHz frequency range. Measures made in the Satimo STARGATE 32 anechoic chamber.