

Versatile RUN mXTEND™: 2G, 3G, 4G & 5G coverage

- **Antenna Component:** RUN mXTEND™ NN02-224
- **Dimensions:** 12.0 mm x 3.0 mm x 2.4 mm
- **Frequency regions:** 698-960 MHz, 1710-2690 MHz and 3400-3800 MHz



The RUN mXTEND™ antenna booster has been designed for providing **top quality mobile** operation at **2G, 3G, 4G** and **5G** in three different frequency regions: 698-960 MHz, 1710-2690 MHz and 3400-3800 MHz.

RUN mXTEND™ allows a **versatile antenna system configuration** for any mobile or IoT device, where you can distribute several antenna components on the printed circuit board. This diverse and reconfigurable antenna booster distribution enables a top quality antenna performance with over a 60% of efficiency rate on the low frequency regions and a 70% efficiency rate on the high frequency ones.

The RUN mXTEND™ antenna booster component and other Fractus Antennas products based on its proprietary Virtual Antenna™ technology are protected by one or more of the following [Fractus Antennas patents](#).

All information contained within this document is property of Fractus Antennas and is subject to change without prior notice. Information is provided “as is” and without warranties. It is prohibited to copy or reproduce this information without prior approval.

Fractus Antennas is an ISO 9001:2015 certified company. All our antennas are lead-free and RoHS and REACH compliant.

ISO 9001: 2015

TABLE OF CONTENTS

1.	PRODUCT DESCRIPTION NN02-224.....	3
2.	EVALUATION BOARD 2 PORT (698-960 MHz, 1710-2690 MHz, 3400-3800 MHz)	4
2.1.	QUICK REFERENCE GUIDE	4
2.2.	EVALUATION BOARD 2 PORT (698-960 MHz, 1710-2690 MHz, 3400-3800 MHz) ...	4

1. PRODUCT DESCRIPTION NN02-224

The RUN mXTEND™ antenna booster has been specifically designed for providing the major level of flexibility to operate any required frequency band inside any wireless device. The RUN mXTEND™ antenna booster is capable of operating the main mobile communication standards, such as GSM850, GSM900, GSM1800/DCS, GSM1900/PCS, UMTS, LTE700, LTE800, LTE850, LTE900, LTE1700, LTE1800, LTE1900, LTE2000, LTE2100, LTE2300, LTE2500, and LTE2600, LTE3500, and LTE3700, through the same antenna component, thus enabling full worldwide 2G, 3G, 4G, and 5G coverage, from 698-960MHz, 1710-2690MHz up to 3400-3800MHz.

The RUN mXTEND™ antenna booster offers the flexibility to be tuned at the frequency regions of interest through the proper adjustment of the matching network. This characteristic provides an important benefit since removes the need of including different antenna parts inside the same wireless device for operating different communication standards, thus reducing considerably the integration complexity while saving costs. The results gathered herein presents how the matching network should be configured for operating the main mobile communication standards of 2G, 3G, 4G, and 5G.

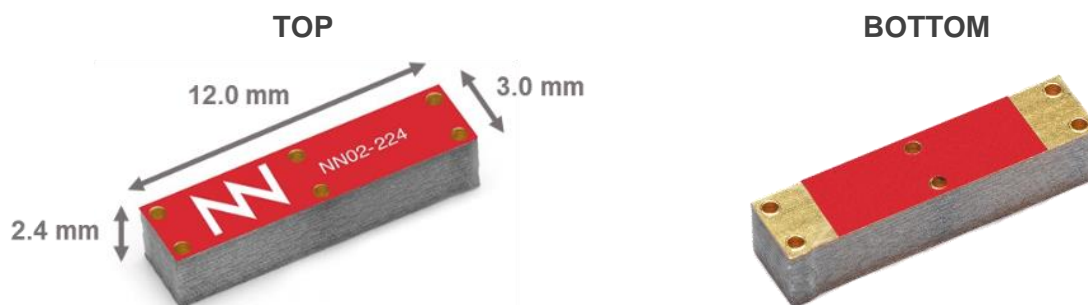

Material: The RUN mXTEND™ antenna booster is built on glass epoxy substrate.

APPLICATIONS

- Handsets
- Smartphones
- Tablets
- Laptop PCs
- Smart Meters
- IoT Devices
- Modules
- Routers

BENEFITS

- High efficiency
- Small size
- Cost-effective
- Easy-to-use (pick and place)
- Multiband behaviour (worldwide standards)
- Off-the-Shelf Standard Product (no customization is required)

The RUN mXTEND™ antenna booster belongs to a new generation of antenna solutions based on the Virtual Antenna™ technology owned by Fractus Antennas. The technology is mainly focused on replacing conventional antenna solutions by miniature and standard components.

2. EVALUATION BOARD 2 PORT (698-960 MHz, 1710-2690 MHz, 3400-3800 MHz)

2.1. QUICK REFERENCE GUIDE

Technical features	698 – 960 MHz	1710 – 2690 MHz	3400 – 3800 MHz
Average Efficiency	> 60 %	> 75 %	> 65 %
Peak Gain	1.6 dBi	3.7 dBi	3.1 dBi
VSWR	< 3:1		
Radiation Pattern	Omnidirectional		
Polarization	Linear		
Weight (approx.)	0.19 g		
Temperature	-40 to +125 °C		
Impedance	50 Ω		
Dimensions (L x W x H)	12.0 mm x 3.0 mm x 2.4 mm		

Table 1 – Technical features. Measures from the Evaluation Board. See Figure 1. Note that for obtaining comparable results, a ground plane length larger than 100 mm is recommended.

2.2. EVALUATION BOARD 2 PORT (698-960 MHz, 1710-2690 MHz, 3400-3800 MHz)

This Evaluation Board (part number: EB_NN02-224-UFL3R-2P) integrates UFL cables to connect the RUN mXTEND™ antenna boosters with the SMA connectors. It works from 698 MHz to 960 MHz, from 1710 MHz to 2690 MHz, and from 3400 MHz to 3800 MHz.

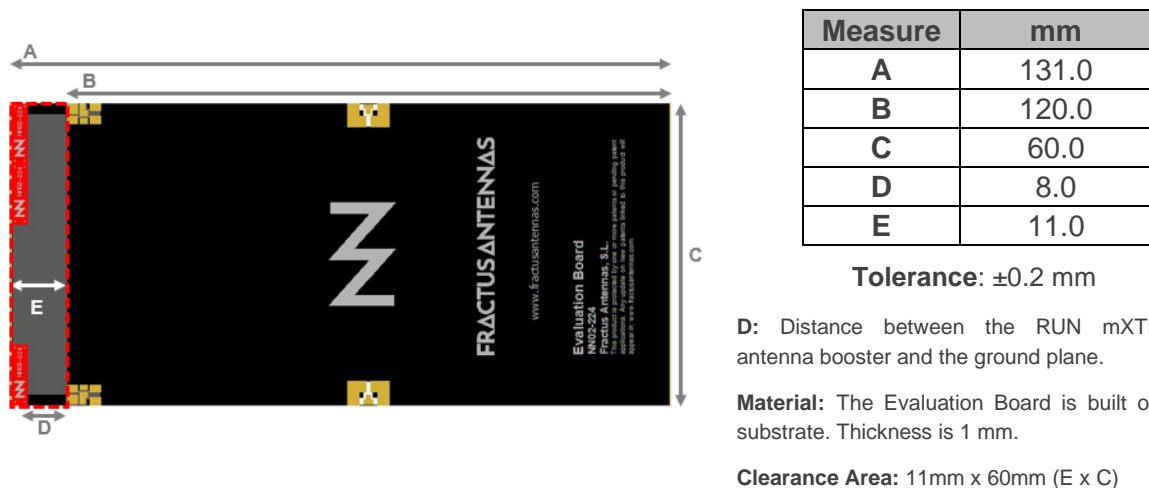

Figure 1 – EB_NN02-224-UFL3R-2P. Evaluation Board providing operation in 3 frequency ranges, 698 MHz to 960 MHz, 1710 MHz to 2690MHz, and 3400 MHz to 3800 MHz.

This product and its use is protected by at least one or more of the following [patents and patent applications](#) US 8,203,492; US 8,237,615; PCT/EP2013/064692; WO2014/012842; US 62/028,494; US 62/072,671; and other domestic and international patents pending. Additional information about patents related to this product is available at <http://www.fractusantennas.com/virtual-antenna/>.

Comments:

- Note that in this case the Evaluation Board (Figure 1) integrates two RUN mXTEND™ antenna boosters that are placed together to provide operation at 698-960MHz frequency range.
- The efficiency measures (Figure 3) are shown from 700 MHz due to the minimum frequency specifications of the Satimo STARGATE 32 anechoic chamber.

2.2.1. MATCHING NETWORKS

The specs of a Fractus Antennas standard product are measured in their Evaluation Board, which is an ideal case. In a real design, components nearby the antenna, LCD's, batteries, covers, connectors, etc. affect the antenna performance. This is the reason why it is highly recommended placing pads compatible with 0402 and 0603 SMD components for a matching network as close as possible to the feeding point. Do it in the ground plane area, not in the clearance area. This provides a degree of freedom to tune the RUN mXTEND™ antenna booster once the design is finished and taking into account all elements of the system (batteries, displays, covers, etc.).

Please notice that different devices with different ground planes and different components nearby the RUN mXTEND™ antenna booster may need a different matching network. To ensure optimal results, the use of high Q and tight tolerance components is highly recommended (Murata components). If you need assistance to design your matching network beyond this application note, please contact support@fractusantennas.com, or try our free-of-charge¹ **NN Wireless Fast-Track** design service, you will get your chip antenna design including a custom matching network for your device in 24h¹. Other related to NN's range of R&D services is available at: <https://www.fractusantennas.com/rdservices/>

¹ See terms and conditions for a free NN Wireless Fast-Track service in 24h at: <https://www.fractusantennas.com/fast-track-project/>

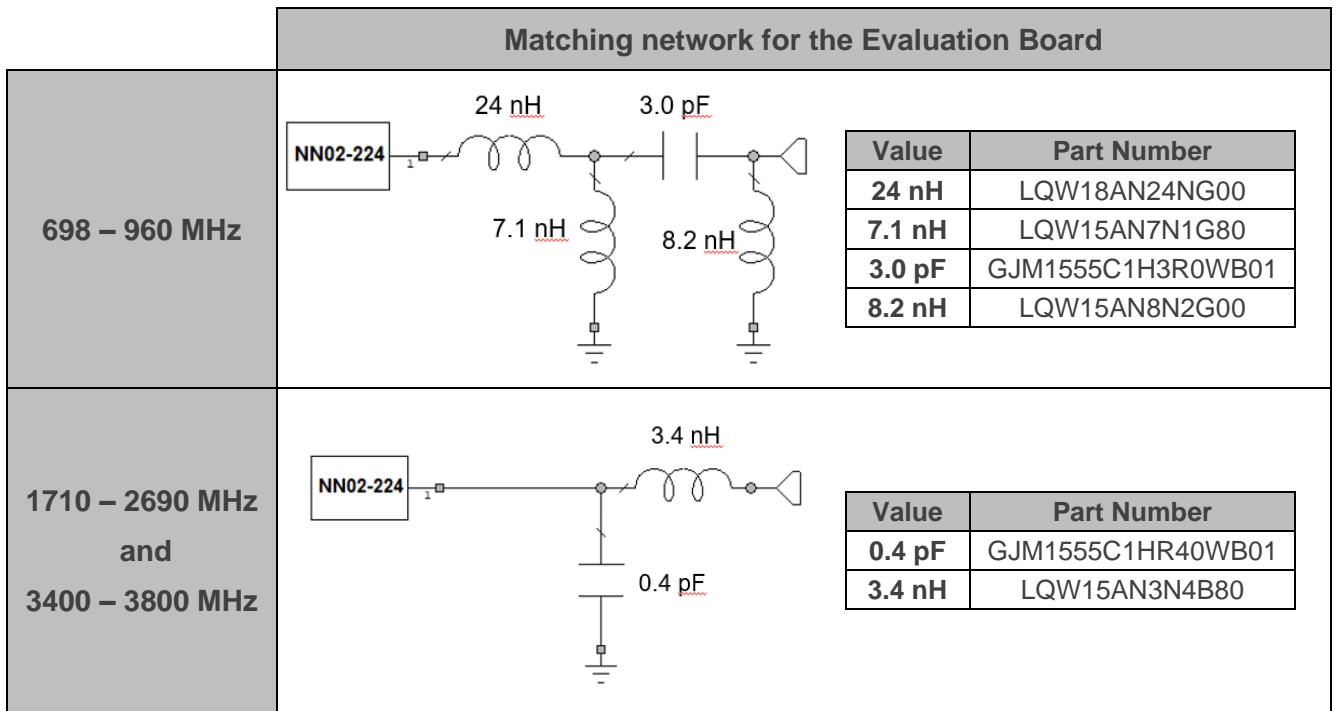

Figure 2 – Matching networks implemented in the Evaluation Board 2 ports (Figure 1).

2.2.2. VSWR AND TOTAL EFFICIENCY

VSWR (Voltage Standing Wave Ratio) and Total Efficiency versus Frequency (GHz).

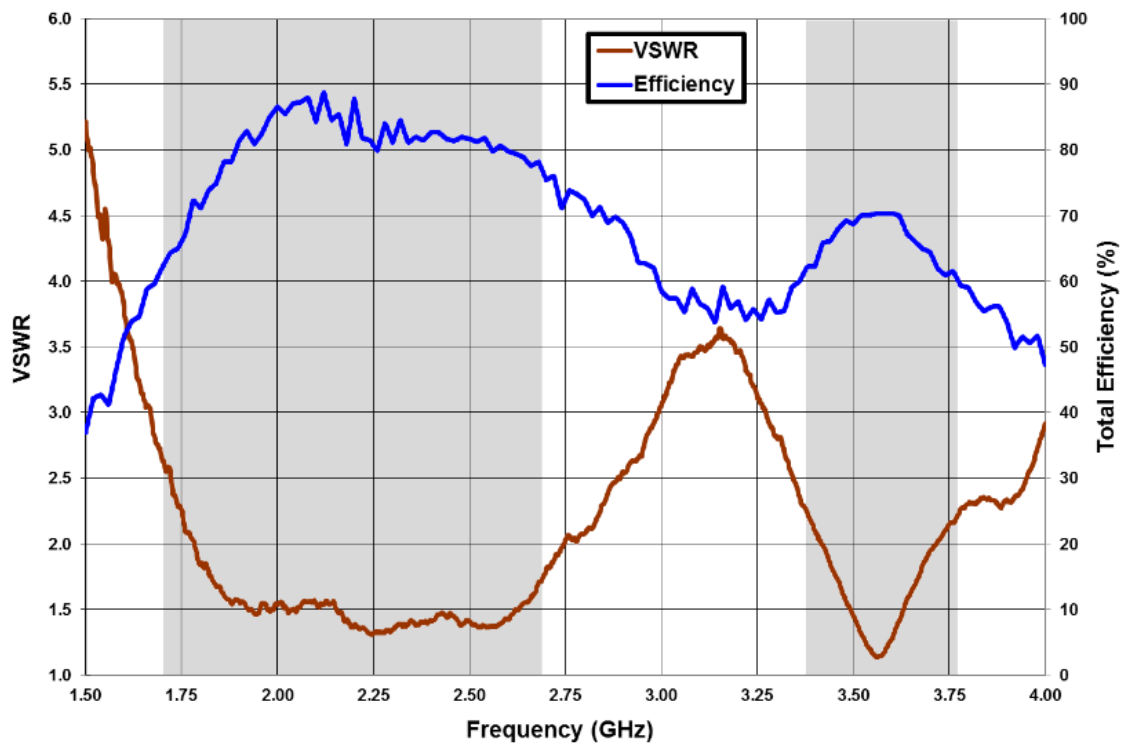
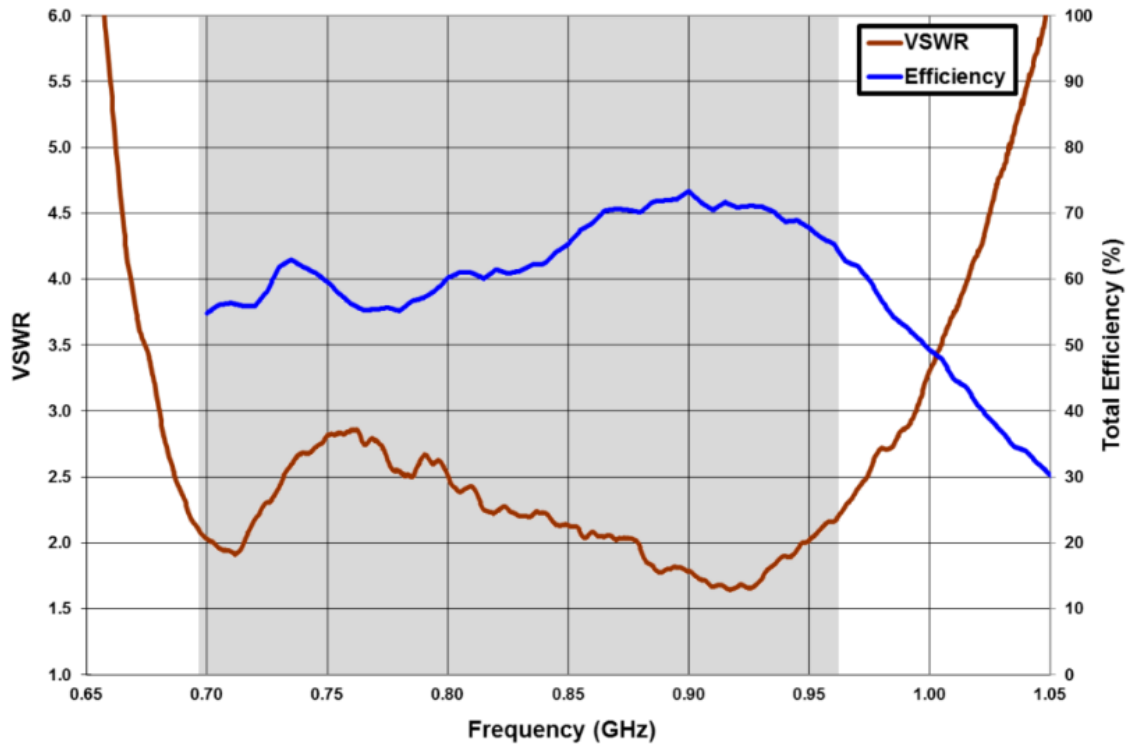
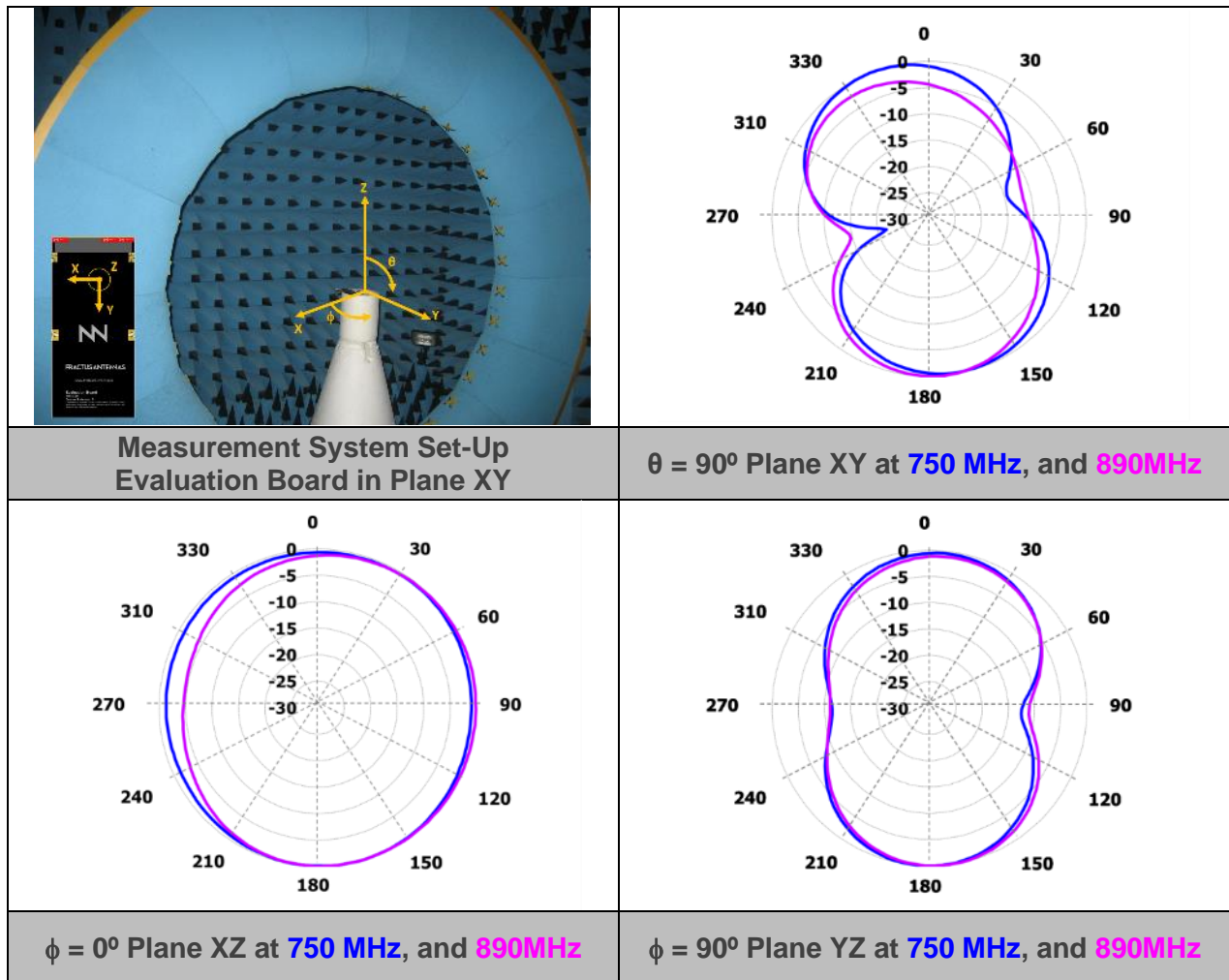

Figure 3 – VSWR and Total Efficiency for the 698 – 960 MHz range, for the 1710 – 2690 MHz, and for the 3400 – 3800 MHz range from the Evaluation Board 2 ports (Figure 1).

2.2.3. RADIATION PATTERNS (698-960 MHz), GAIN AND EFFICIENCY



Gain	Peak Gain	1.6 dBi
	Average Gain across the band	0.8 dBi
	Gain Range across the band (min, max)	-0.1 <-> 1.6 dBi
Efficiency	Peak Efficiency	73.4 %
	Average Efficiency across the band	63.7 %
	Efficiency Range across the band (min, max)	54.9 – 73.4 %

Table 2 – Antenna Gain and Total Efficiency from the Evaluation Board (Figure 1) within the 698 – 960 MHz range. Measures made in the Satimo STARGATE 32 anechoic chamber.

2.2.4. RADIATION PATTERNS (1710-2690 MHz), GAIN AND EFFICIENCY

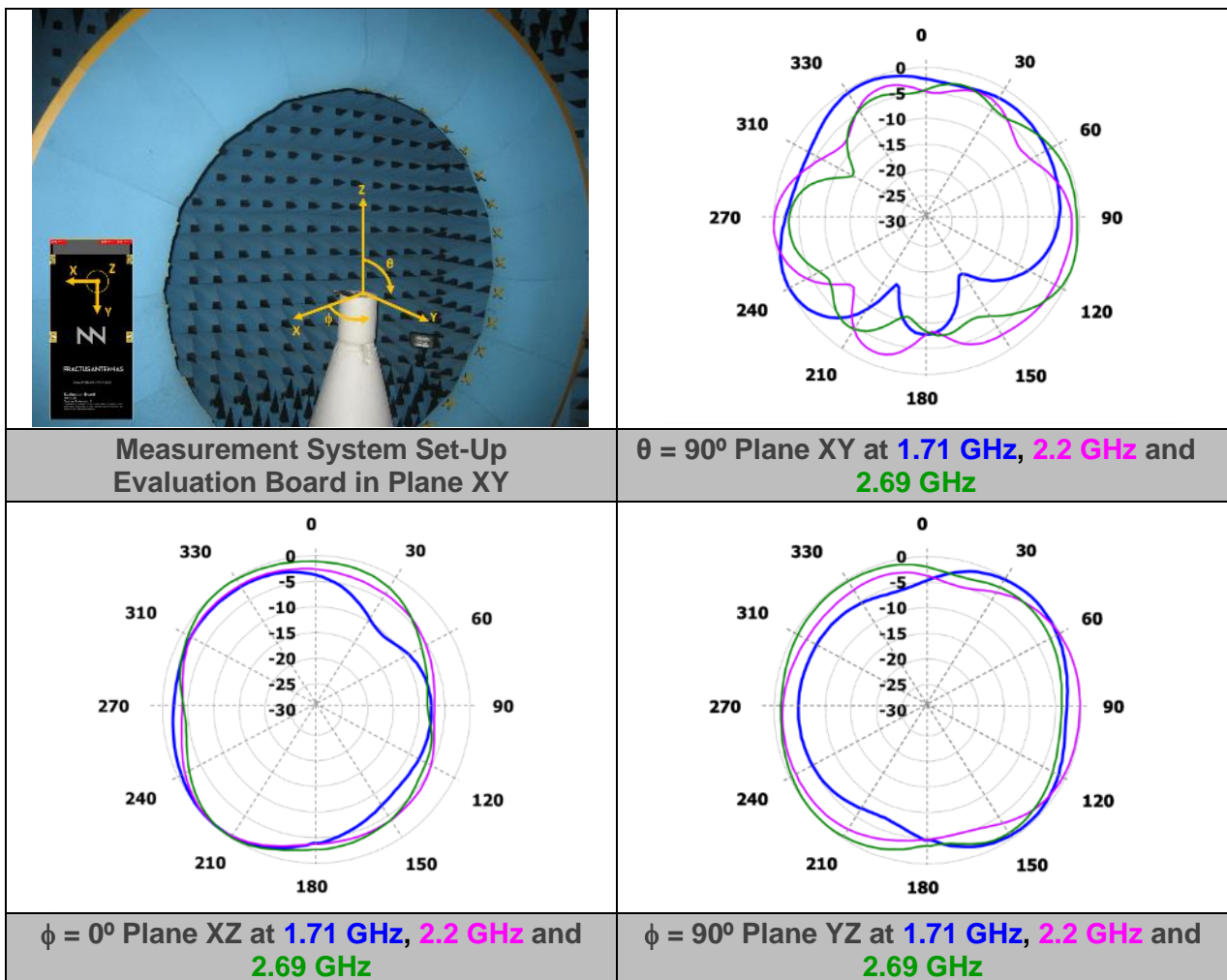

Gain	Peak Gain	3.7 dBi
	Average Gain across the band	2.6 dBi
	Gain Range across the band (min, max)	1.8 <-> 3.7 dBi
Efficiency	Peak Efficiency	88.7 %
	Average Efficiency across the band	80.6 %
	Efficiency Range across the band (min, max)	63.3 – 88.7 %

Table 3 – Antenna Gain and Total Efficiency from the Evaluation Board (Figure 1) within the 1710 – 2690 MHz range. Measures made in the Satimo STARGATE 32 anechoic chamber.

2.2.5. RADIATION PATTERNS (3400-3800 MHz), GAIN AND EFFICIENCY

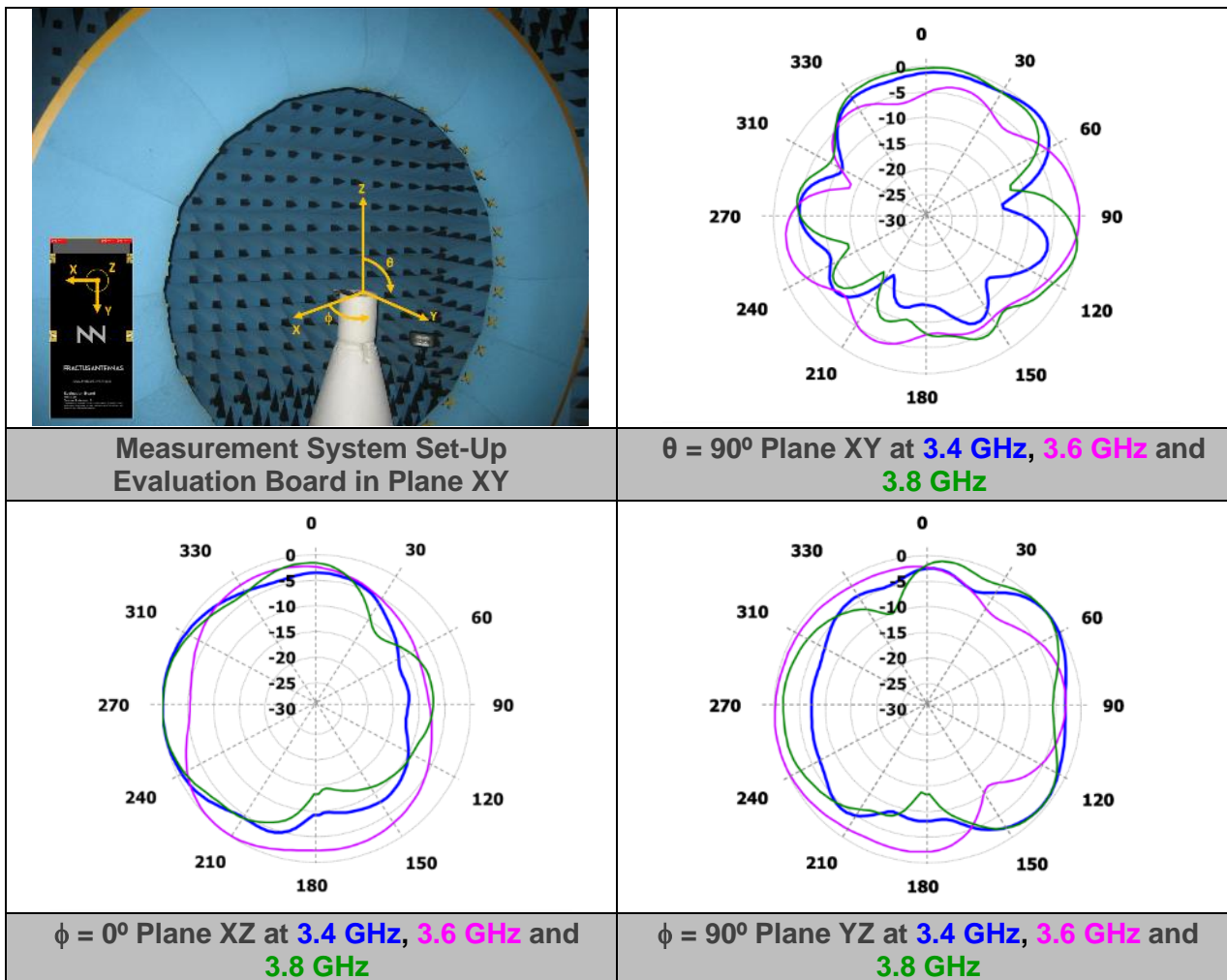

Gain	Peak Gain	3.1 dBi
	Average Gain across the band	2.9 dBi
	Gain Range across the band (min, max)	2.5 <-> 3.1 dBi
Efficiency	Peak Efficiency	70.3 %
	Average Efficiency across the band	66.3 %
	Efficiency Range across the band (min, max)	59.0 – 70.3 %

Table 4 – Antenna Gain and Total Efficiency from the Evaluation Board (Figure 1) within the 3400 – 3800 MHz range. Measures made in the Satimo STARGATE 32 anechoic chamber.